



KONGSBERG

Instruction Manual

ACS500

Acoustic Control System





KONGSBERG

Kongsberg ACS500 Acoustic Control System

Instruction Manual

322135/N

December 2018 © Kongsberg Maritime AS

Revision status

Document number: 322135 / Revision N		
Rev. N	December 2018	New type approval certificate with auto shutdown system.

Copyright

©2018 Kongsberg Maritime AS

The information contained in this document remains the sole property of Kongsberg Maritime AS. No part of this document may be copied or reproduced in any form or by any means, and the information contained within it is not to be communicated to a third party, without the prior written consent of Kongsberg Maritime AS. The document, or any part of it, may not be translated to any other language without the written approval from Kongsberg Maritime AS.

Disclaimer

Kongsberg Maritime AS endeavours to ensure that all information in this document is correct and fairly stated, but does not accept liability for any errors or omissions.

Warning

The equipment to which this manual applies must only be used for the purpose for which it was designed. Improper use or maintenance may cause damage to the equipment and/or injury to personnel. All users must be familiar with the contents of the appropriate manuals before attempting to install, operate, maintain or in any other way work on the equipment. Kongsberg Maritime AS disclaims any responsibility for damage or injury caused by improper installation, use or maintenance of the equipment.

Table of contents

ABOUT THIS MANUAL	9
ACS500	10
System description	11
System diagram	12
System units	13
Acoustic Command Unit	13
Dunking transducer unit	13
Subsea transducer	14
Subsea Control Unit	14
Field simulator	14
List of parts	15
General supply conditions	15
Receipt, unpacking and storage	15
Equipment responsibility	15
Support information	16
PLANNING THE ACS500 INSTALLATION	17
Installation drawings	18
INSTALLING THE SUBSEA CONTROL UNIT	19
Installing the Subsea Control Unit	19
INSTALLING THE SUBSEA TRANSDUCER	20
Installing the subsea transducer	20
CABLE LAYOUT AND INTERCONNECTIONS	22
Cable plan	23
List of cables	24
Cable procedures	25
Connecting the cable from the Subsea Control Unit to the external quad battery unit (option)	26
Connecting the transducer cable from the Subsea Control Unit to the subsea transducer	26
Connecting the cable from the Subsea Control Unit to the junction box	27
Connecting the cable from the junction box to the valve package	27
GETTING STARTED	28
Dunking transducer with cable drum	28
Opening the cable drum	28
Closing the cable drum	29
Starting operation	29
Powering on the ACS500	29
Powering off the ACS500	30

Starting up the surface system.....	30
Valve operation.....	31
ACOUSTIC COMMAND UNIT.....	32
ACU Computer buttons.....	35
Changing the brightness and computer exit.....	35
Power button and battery level.....	35
Trackball.....	35
User interface	36
Menu bar.....	37
System Status	38
Battery status.....	38
Sensor Input	39
More Status	39
Help.....	40
Subsea Telemetry Power	40
Execute	40
SCU Solenoid Information	40
Exit.....	40
OPERATIONAL PROCEDURES	41
Valve operation.....	41
Battery level	43
Battery status, Acoustic Command Unit.....	43
Battery status, Subsea Control Unit.....	43
External battery capacity	43
User settings	44
Setting the telemetry power level for the ACU.....	44
Setting the telemetry power level for the Subsea Control Unit.....	45
Changing between Cymbal and FSK.....	45
System status	46
Checking communication between the Acoustic Command Unit and the Subsea Control Unit.....	46
Reading the system status information.....	46
Reading the sensor input	47
Reading the software versions	47
Emergency sequence	48
Operating ACS500 from HiPAP (optional).....	48
Auto Shutdown (option).....	49
Valves used in the sequence.....	50
Sequence operation and timing	50
Enabling/Disabling Auto Shutdown	50
Messages	53
No response from SCU	53

Link status.....	53
System status.....	54
BOP status	55
Battery status.....	56
Sensor input	56
More status.....	57
Valve operation messages.....	57
Case 1; The valve package is not in Arm mode	61
Case 2; Trying to activate a valve function twice.....	63
Case 3; Getting no status reply after execution of a valve	64
Case 4; Trying to activate the Arm function twice	65
Case 5; Executing a Disarm function when a valve function is still active	65
SIMULATION AND TEST	67
Connecting the test equipment	68
Alternative 1.....	69
Alternative 2 (preferred method).....	69
Test procedure	69
Testing ACS500 with HiPAP	71
MAINTENANCE.....	73
Acoustic Command Unit.....	74
Cleaning the Acoustic Command Unit.....	74
Charging the Acoustic Command Unit	74
Changing the battery on the Acoustic Command Unit	75
Dunking transducer	76
Cleaning the dunking transducer	76
Checking the dunking transducer	76
Subsea Control Unit	77
SCU maintenance overview.....	77
Cleaning the Subsea Control Unit	77
Opening the Subsea Control Unit.....	78
Changing the battery on the Subsea Control Unit	79
Testing the seals on the Subsea Control Unit	80
Replace a Subsea Control Unit and duplicate the configuration	81
External quad battery unit for the Subsea Control Unit.	82
Quad battery maintenance overview.....	82
Cleaning the external quad battery unit.....	83
Opening the external quad battery unit	83
Changing the batteries in the external quad battery unit	84
Subsea transducer.....	85
Cleaning the subsea transducer	85
Replacing the subsea transducer.....	85

Interseal test.....	87
Assemble the test kit	87
Testing the seal	88
Changing the battery in the Digital pressure indicator.....	89
ILLUSTRATED SPARE PARTS CATALOGUE	91
Line replaceable units.....	92
Ordering spare parts	93
Acoustic Command Unit spare parts	93
Acoustic Command Unit line replaceable units	93
Acoustic Command Unit, complete unit	94
Acoustic Command Unit, battery	94
Dunking transducer spare parts	94
Dunking transducer line replaceable units.....	94
Dunking transducer, complete unit	94
Subsea Control Unit spare parts	95
Subsea Control Unit line replaceable units.....	95
Subsea Control Unit, complete unit	96
Subsea Control Unit, battery	96
Subsea Control Unit, top end cap	96
Subsea Control Unit, vent screw for top end cap	96
Subsea Control Unit, maintenance kit for top end cap.....	97
Subsea Control Unit, bracket	97
Subsea Control Unit, junction box.....	97
Subsea Control Unit, interface jumper cable	97
Subsea Control Unit, interface cable.....	98
Subsea Control Unit, serial line cable	98
Subsea Control Unit, sealing cap for 12-pins connector	98
Subsea Control Unit, external quad battery unit	98
Subsea transducer spare parts.....	98
Subsea transducer line replaceable units	98
Subsea transducer, complete unit	99
Test equipment spare parts	99
Test equipment line replaceable units	100
Simulator	100
Simulator test cable.....	100
Patch cable for testing with HiPAP.....	100
Transducer test cable.....	100
Interseal test kit	101
O-ring kits.....	101
O-ring for external quad battery	101
EQUIPMENT HANDLING	102
Disposal	103

Inspection	103
Lifting	103
Re-packaging	104
Storage after unpacking	104
Storage after use	105
Cleaning cabinets	105
Mechanical units	105
Cables	106
Dehumidifier	106
Coatings	106
Storage prior to installation or use	106
Unpacking	107
General unpacking procedure	107
Unpacking electronic and electromechanical units	108
Unpacking mechanical units	108
Transportation	109
DRAWING FILE	110
Dunking transducer unit, outline dimensions	111
Acoustic Command Unit, outline dimensions	112
Subsea Control Unit, outline dimensions	113
Subsea Control Unit, arrangement	114
Subsea Control Unit, bracket	115
TDR30V Subsea transducer, outline dimensions	116
TDR40V 34S Subsea transducer, outline dimensions	117
TDR180 Subsea transducer, outline dimensions	118
External quad battery unit for SCU, outline dimensions	119
16 channel field simulator, outline dimensions	120
TECHNICAL SPECIFICATIONS	121
Acoustic link	122
Performance specifications	123
Weights and outline dimensions	124
Power specifications	125
Environmental specifications	126
LITHIUM BATTERIES SAFETY PROCEDURES	127
SECTION 1: Identification	127
Product name	127
Hazards identification	128
Other hazards	128
SECTION 3: Composition	128
Battery cell manufacturers/types	129

Battery design.....	129
SECTION 4: First-aid measures	129
SECTION 5: Fire-fighting measures.....	129
SECTION 6: Accidental release measures	130
SECTION 7: Handling and storage	130
SECTION 8: Exposure controls and personal protection	131
SECTION 9: Physical and chemical properties.....	131
SECTION 10: Stability and reactivity	131
SECTION 11: Toxicological information	132
SECTION 12: Ecological information.....	132
SECTION 13: Disposal considerations.....	132
SECTION 14: Transport information	132
SECTION 15: Regulatory information	133
SECTION 16: Other information.....	133
A TYPE APPROVAL CERTIFICATE.....	134
B INFORMATION FROM THE CONNECTOR PRODUCER	139

About this manual

Purpose

The purpose of this instruction manual is to provide the descriptions and procedures required to allow for safe and efficient installation and use of the Kongsberg ACS500.

Target audience

This manual is intended for all users of Kongsberg ACS500.

Registered trademarks

Windows®, Windows XP®, and Windows® 7 are either registered trademarks, or trademarks of Microsoft Corporation in the United States and/or other countries.

HIPAP® is a registered trademark of Kongsberg Maritime AS in Norway and other countries.

WARNING

Subsea Control Unit batteries:

Change batteries with less residual capacity than 25%, batteries older than 10 years, batteries used for more than 1 year, and batteries with unknown status.

ACS500

Study this chapter to familiarize yourself with the Kongsberg ACS500.

Topics

- *System description* on page 11
- *System diagram* on page 12
- *System units* on page 13
- *List of parts* on page 15
- *General supply conditions* on page 15
- *Support information* on page 16

System description

ACS500 is designed for optimal control of subsea valves and is rated to 4000 metre depth.

ACS500 may be used to control an blow out preventer system as an emergency system or other subsea valve control functions.

System diagram

A standard ACS500 system diagram is provided.

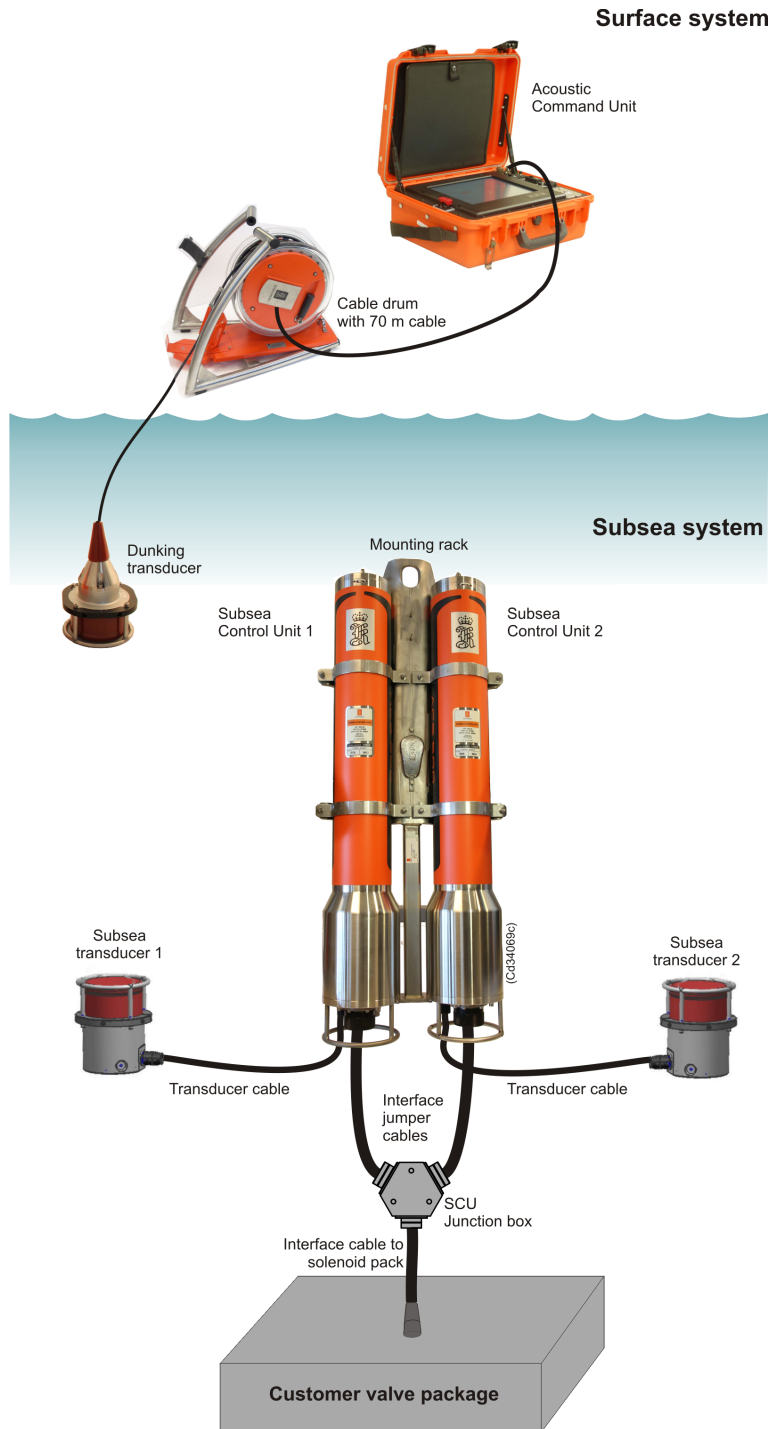

System units

The Kongsberg ACS500 comprises the following main units.

Topics

- *Acoustic Command Unit* on page 13
- *Dunking transducer unit* on page 13
- *Subsea Control Unit* on page 14
- *Subsea transducer* on page 14
- *Field simulator* on page 14

Acoustic Command Unit

The ACU is the main system interaction unit.

The ACU comprises a computer and a touch screen in a splash proof portable case.

The ACU has an internal rechargeable battery with approximately 10 hours of continuous operation on a fully charged battery.

The customer also have the option of using the ACU as an emergency system if the computer is down. A predefined valve sequence may be executed using a two hand, two button operation.



Dunking transducer unit

The transducer will convert electric energy into pressure waves in the water. The characteristics of these pressure waves - power, frequency and shape - are determined by the electric signal applied to the transducer.



Subsea transducer

The transducer will convert electric energy into pressure waves in the water. The characteristics of these pressure waves - power, frequency and shape - are determined by the electric signal applied to the transducer.



Subsea Control Unit

The SCU is the unit controlling the subsea valves.

Commands are sent from the ACU via the transducers and sent from the SCU to the valves.



Field simulator

The simulator is used for simulating the valves when the SCU is at the surface, to check the system functionality.

The simulator is connected to the SCU with a test cable.



List of parts

Important

See Scope of delivery in the registration form for the units in your system.

General supply conditions

The following general supply conditions apply to this Kongsberg ACS500 delivery.

Topics

- *Equipment responsibility* on page 15
- *Receipt, unpacking and storage* on page 15

Receipt, unpacking and storage

Upon accepting shipment of the equipment, the shipyard and/or the dealer should ensure that the delivery is complete and inspect each shipping container for evidence of physical damage. If this inspection reveals any indication of crushing, dropping, immersion in water or any other form of damage, the recipient should request that a representative from the company used to transport the equipment be present during unpacking.

All equipment must be inspected for physical damage, i.e. broken controls and indicators, dents, scratches etc. during unpacking. If any damage to the equipment is discovered, the recipient should notify both the transportation company and Kongsberg Maritime so that Kongsberg Maritime can arrange for replacement or repair of the damaged equipment.

Once unpacked, the equipment must be stored in a controlled environment with an atmosphere free of corrosive agents, excessive humidity or temperature extremes. The equipment must be covered to protect it from dust and other forms of contamination when stored.

For more information, see the information related to equipment handling.

Related topics

- *Equipment handling* on page 102

Equipment responsibility

The shipyard performing the installation and/or equipment the dealer becomes fully responsible for the equipment upon receipt unless otherwise stated in the contract.

The duration of responsibility includes:

- The period of time the equipment is stored locally before installation.
- During the entire installation process.
- While commissioning the equipment.
- The period of time between commissioning and the final acceptance of the equipment by the end user (normally the owner of the vessel the equipment has been installed onto).

Unless other arrangements have been made in the contract, the Kongsberg ACS500 guarantee period (as specified in the contract) begins when the acceptance documents have been signed.

Support information

If you need technical support on the ACS500 you must contact Kongsberg Maritime.

- **Address:** Strandpromenaden 50, 3190 Horten, Norway
- **Telephone, 24h:** +47 33 03 24 07
- **Telefax:** +47 33 04 76 19
- **E-mail address:** km.support@kongsberg.com
- **Website:** <http://www.km.kongsberg.com>
- **Support website:** http://www.km.kongsberg.com/support_hpr

Planning the ACS500 installation

This chapter provides the information necessary to plan the installation of the Kongsberg ACS500 according to Kongsberg Maritime's requirements.

Correct installation is vital to the system performance.

See your registration form for all parts of your system including cables.

Topics

- *Installation drawings* on page 18

Installation drawings

All installation drawings must be supplied by the shipyard performing the installation.

Note

The installation shipyard must provide all necessary installation drawings, and if required, these must be approved by the applicable authorities.

Note

The installation must be approved by the vessel's national registry and corresponding maritime authority and/or classification society. The shipowner and shipyard performing the installation are responsible for obtaining and paying for installation approval.

Kongsberg Maritime offers free advice for installation planning. Proposed arrangements may be sent for commentary or suggestions supplied by Kongsberg Maritime. The following drawings should be submitted should assistance be requested:

- General arrangement
- Body plan and drawings of the relevant compartment
- Lines plan

Related topics

- *Drawing file* on page 110

Installing the Subsea Control Unit

This chapter explains how to install the SCU.

Note _____

The installation shipyard must provide all necessary installation drawings, and if required, these must be approved by the applicable authorities.

Installing the Subsea Control Unit

Purpose

This procedure explains how to install the SCU.

Procedure

1 The SCU comes secured on a mounting bracket.

- See the *Drawing file* on page 110.

Mount the bracket onto the valve control structure by the hooks behind the SCUs.

The bracket is constructed to hold the units in an upright position.

2 Secure the SCU with four M12 bolts with nuts and spring washers.

Note _____

These bolts are not provided as the types and lengths will depend on the thickness and material of the valve control structure.

3 Tighten the bolts to the torque recommended by the bolt manufacturer.

Installing the subsea transducer

This chapter explains how to install the ACS500 transducer.

Note

The installation shipyard must provide all necessary installation drawings, and if required, these must be approved by the applicable authorities.

Installing the subsea transducer

Purpose

This procedure explains how to install the subsea transducer.

Procedure

- 1 The two transducers must be mounted on the valve framework. The transducers must be located at opposite sides of the valve package, and must be positioned such that they have a clear line of sight to the surface. They should be located as far away from the valve structure and other reflective surfaces as possible to reduce the effects of acoustic shadowing and echoes.

Note

The subsea transducer should be positioned minimum 2.5 metres from the valve structure.

- 2 Prepare the location and the necessary tools.
 - See the *Drawing file* on page 110 and your transducer for location of the holes.
- 3 Secure the transducer with six M6 bolts, nuts and spring washers.

Note

These bolts are not provided as the types and lengths will depend on the thickness and material of the mounting structure.

- 4 Tighten the bolts to the torque recommended by the bolt manufacturer.
If A4 or similar bolts are used, tighten the bolts to a torque of 40 Nm.

Cable layout and interconnections

This chapter provides the cable plan and cable installation requirements for the Kongsberg ACS500.

Topics

- *Cable plan* on page 23
- *List of cables* on page 24
- *Cable procedures* on page 25

Cable plan

Observe the cable plan for Kongsberg ACS500. All cables are provided from Kongsberg Maritime.

System with y-split cable

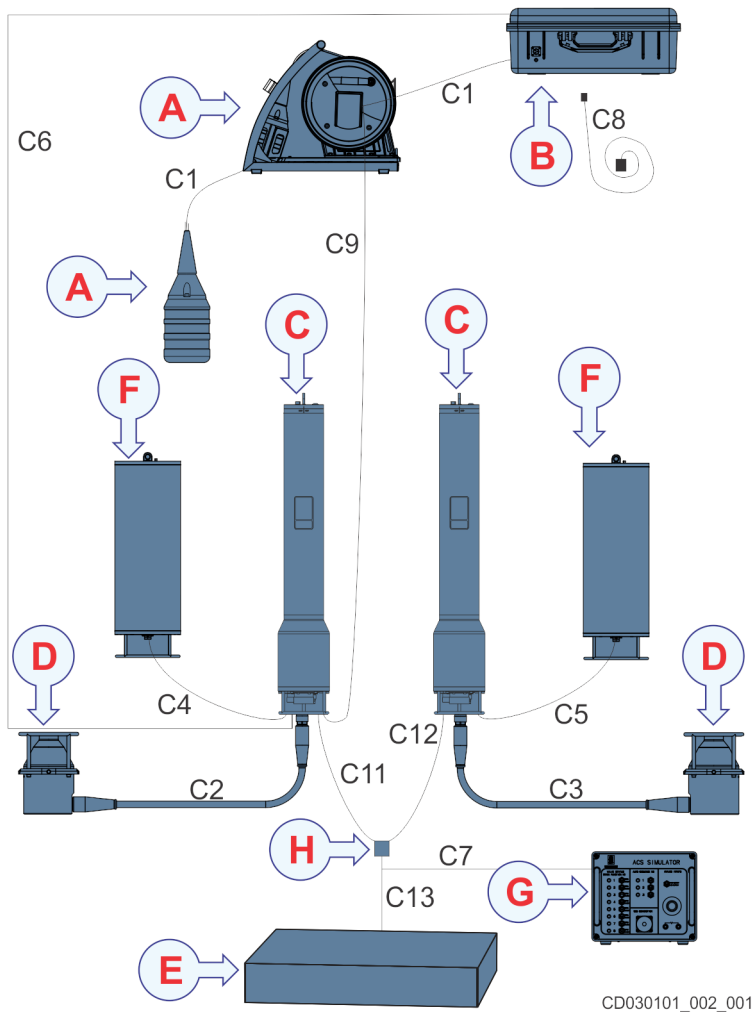

- A *Dunking transducer with cable drum*
- B *Acoustic Command Unit*
- C *Subsea Control Unit*
- D *Subsea Transducer*
- E *Customer valve package*
- F *Quad battery pack*
- G *Field simulator*
- H *Junction box*

List of cables

Observe the list of cables for the Kongsberg ACS500. The C_x numbers refer to the cable plan. References are made to the individual cable drawings specifying each cable with its connectors.

See scope of delivery in the registration form for the specific cables in your system.

C1 Dunking transducer cable

This cable provides the signals to and from the Acoustic Command Unit.

The cable is on a cable drum, is 70 metres long and part of the dunking transducer unit.

C2 Subsea transducer cable

This cable provides the signals to and from the Subsea Control Unit and is 15 metres long. The cable is moulded on the transducer side.

C3 Subsea transducer cable

This cable is identical to C2.

C4 Subsea battery cable (optional)

This cable is connecting the external battery to the Subsea Control Unit and is 2 metres long.

C5 Subsea battery cable (optional)

This cable is identical to C4.

C6 Transducer test cable

This cable is for testing in air, is 50 metres long and on a cable drum.

C7 Field simulator test cable

This cable is for simulation and testing and is customer specific.

C8 Charging cable for the Acoustic Command Unit.

C9 Patch cable for testing with HiPAP.

This cable is for testing with the HiPAP system.

C10 N/A

C11 Interface jumper cable

This cable connects the Subsea Control Unit to the junction box and is 2 metres long.

C12 Interface jumper cable

This cable is identical to C11.

C13 Interface cable

This cable connects the junction box to customer valve package and is 5 metres long. This cable is customer specific.

Cable procedures

Observe the following procedures to do the ACS500 cabling.

- 1 All cables are provided by Kongsberg Maritime.
- 2 In order to ease access for maintenance purposes, and to allow for vibration, make sure that some slack is provided for each cable.

Topics

- *Connecting the cable from the Subsea Control Unit to the external quad battery unit (option) on page 26*
- *Connecting the transducer cable from the Subsea Control Unit to the subsea transducer on page 26*
- *Connecting the cable from the Subsea Control Unit to the junction box on page 27*
- *Connecting the cable from the junction box to the valve package on page 27*

Connecting the cable from the Subsea Control Unit to the external quad battery unit (option)

Purpose

This cable provides power from the external batteries to the SCU.

Procedure

- 1 The system must be turned off before connecting the external quad batteries. Make sure the ACU is switched off and the lids are off the SCUs.
- 2 Secure the cable on the structure for the valve package so that they do not present a hazard to ROVs etc. Make sure there is slack for moving parts.
- 3 Mount any protective covers necessary to prevent the cables being damaged.
- 4 Connect the cable to the SCUs as indicated. Connect the other end to the external battery unit.

These are cables ACS500/C4 and ACS500/C5.

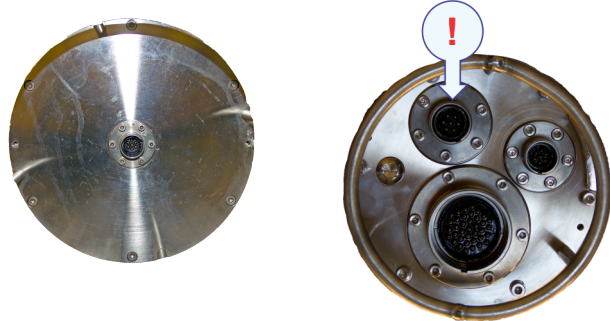

Connecting the transducer cable from the Subsea Control Unit to the subsea transducer

Purpose

This cable provides the signals from the transducer to the SCU and back.

Procedure

- 1 Secure the cable on the structure for the valve package so that they do not present a hazard to ROVs etc. Make sure there is slack for moving parts.
- 2 Mount any protective covers necessary to prevent the cables being damaged.
- 3 Connect the cable to the SCU as indicated.

These are cables ACS500/C2 and ACS500/C3.

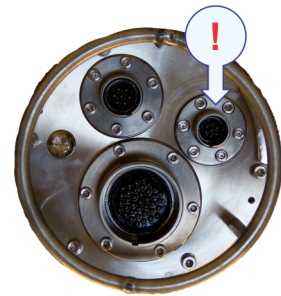

Connecting the cable from the Subsea Control Unit to the junction box

Purpose

This cable provides the signals from the valve package to the SCU and back.

Procedure

- 1 Secure the cable on the structure for the valve package so that they do not present a hazard to ROVs etc. Make sure there is slack for moving parts.
- 2 Mount any protective covers necessary to prevent the cables being damaged.
- 3 Connect the cable to the SCU as indicated. Connect the other end to the junction box.
These are cables ACS500/C4 and ACS500/C5.

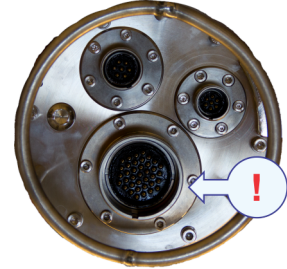

Connecting the cable from the junction box to the valve package

Purpose

This cable provides the signals from the valve package to the SCU and back.

Procedure

- 1 Secure the cable on the structure for the valve package so that they do not present a hazard to ROVs etc. Make sure there is slack for moving parts.
- 2 Mount any protective covers necessary to prevent the cables being damaged.
- 3 Connect the cable to the junction box connector. Connect the other end to the valve package.

This is cable ACS500/C6.

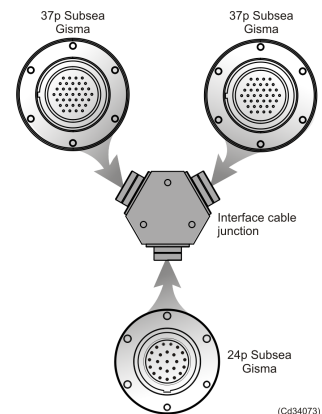

Getting started

This chapter describes how to get started with the basic operation of the ACS500 system.

Topics

- *Dunking transducer with cable drum* on page 28
- *Starting operation* on page 29

Dunking transducer with cable drum

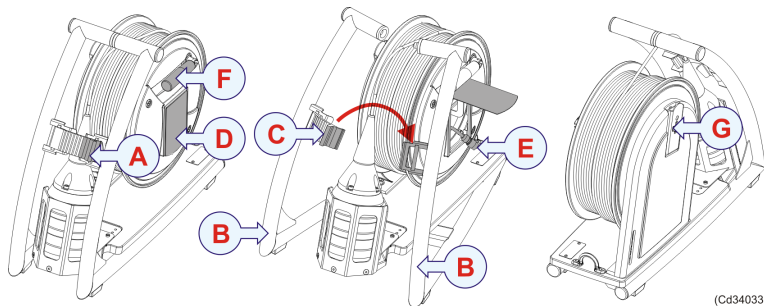

- A** Locking clip, open
- B** Bars
- C** Locking clip, closed
- D** Cover
- E** Cable connection, 1.5 metres
- F** Handle
- G** Drum lock

- *Opening the cable drum* on page 28
- *Closing the cable drum* on page 29

Opening the cable drum

Procedure

- 1 Pull the locking clip A towards you to open the unit.

- 2 Unlock the transducer cable by pulling the drum lock **G** slightly out.
- 3 Reel out the dunking transducer to the right depth, and lock the cable by pushing the drum lock **G** back in.
- 4 Lift up the cover **D** to find the cable connection to the ACU.
- 5 Pull out the cable **E** and connect to the ACUs connector **B**.

Closing the cable drum

Note

Clean the unit, cable and transducer before storage.

Procedure

- 1 Roll up the cable **E** and place it inside the drum under the cover **D**.
- 2 Pull in the dunking transducer.
- 3 Clean the transducer and cable with freshwater.
- 4 Use the handle **F** to reel in the transducer cable.
- 5 Place the transducer in the basket.
- 6 Lock the transducer cable by pushing the drum lock **G** in.
- 7 Fold in the handle **F**.
- 8 Press the two bars **B** together and press the locking clip **C** into position.

Starting operation

Once you have powered up the complete ACS500 system, you are ready to start the actual operation.

Topics

- *Powering on the ACS500* on page 29
- *Powering off the ACS500* on page 30
- *Starting up the surface system* on page 30
- *Valve operation* on page 31

Powering on the ACS500

Procedure

- 1 The SCU is powered up by inserting the battery and switching the stab connector on the inside of the top end cap to on. Close the top end cap.
See *Changing the battery on the Subsea Control Unit* on page 79.
- 2 Power on the ACU by pressing the **Power** button **D** to the ON position.
The ACU takes about 2 minutes to start.

Powering off the ACS500

Procedure

- 1 The SCU is powered off by opening the top end cap and removing the battery.
See *Opening the Subsea Control Unit* on page 78.
- 2 Press the **Power** button **D** to the OFF position, to turn off the ACU.

Tip

Tapping **Exit** on the touch screen only turns the computer off, the rest of the system is still using battery power. Always use the power button to switch off the ACU.

Starting up the surface system

Purpose

This procedure shows how to start up the system.

Procedure

- 1 Place the ACU in a suitable location and open the lid by pressing the handle knobs and pulling the handles towards you.



- 2 Turn on the ACU with the **Power** button **D** on the right hand side.
The system takes about 2 minutes to start up, continue with the cables while the system starts.
- 3 Place the cable drum with the dunking transducer close to the ACU.
- 4 Prepare the dunking transducer for operation.
See *Opening the cable drum* on page 28.
- 5 Pull out the cable and lower the transducer to a depth at least 10 meters below the lowest draft of the platform/vessel.
- 6 Connect the transducer cable to the connector marked TD on the top right hand side of the ACU.
- 7 The system is ready for use.

Valve operation

Purpose

This procedure shows how to start up the subsea system.

The system is delivered with the batteries separate as a safety precaution.

Procedure

- 1 Select the tab with the SCU you want to use.
- 2 Test if there is communication between the surface and the subsea system.
In the **Battery Status** section, tap **Read**.
See [Checking communication between the Acoustic Command Unit and the Subsea Control Unit](#) on page 46.
- 3 In the **SCU Solenoid Information** section, tap the function you want to execute.
- 4 Press **Execute, F** on the left side of the ACU and tap **Execute, N** on the touch screen at the same time.
- 5 Observe the colour and text of the valve symbol to see if the operation was successful.
 - Green – The valve operation is done.
 - Dark green – The valve operation is done, and the system has sent a warning, the warning is displayed by the valve symbol.
Low battery or **High currents** are examples of warnings.
 - Red – An error happened during the valve operation. The error message is displayed by the valve symbol.
See [Messages](#) on page 53 for examples.

Acoustic Command Unit



(Cd34077)

This chapter contains detailed descriptions of the ACS500 control panel.



(Cd34077)

- A Serial line connector for service personnel only
- B Dunking transducer connector
- C USB and LAN connectors for service personnel only
- D **Power** switch
- E Emergency control (option)
- F **Execute** button for two hand operation
 - Use with the ACU control menu to do valve operations.
 - Use with the **Emergency** button to start an emergency sequence.
- G Trackball and mouse controls for operational use
- H This will only turn off the computer, the hardware will still drain the battery. Use button **D** to power off the system.
- I Display brightness adjustment
- J Charger connector
- K Gas lift springs
- L Battery charging cable stored in folder
- M Battery level indicator
- N Touch screen **Execute** button
- O Touch screen **Exit** button. Use button **D** to power off the system.
- P Online help button

- *ACU Computer buttons* on page 35
- *User interface* on page 36

ACU Computer buttons

Use these buttons and indicators with the ACU.

- *Changing the brightness and computer exit* on page 35
- *Power button and battery level* on page 35
- *Trackball* on page 35

Changing the brightness and computer exit

Use the + and – buttons below the display to increase and decrease the brightness of the screen.

Avoid using the computer's power off button. This turns the computer off without saving any changes.

Use the **Power** button **D**.



Power button and battery level

The battery level indicator **M** shows you how much battery power is left. A green LED is lit when you have full capacity, an orange LED is lit at half capacity and a red LED is blinking when the battery is almost empty and needs to be recharged.

The **Power** button **D** is where you turn the ACU off and on. Always use this button for powering off.

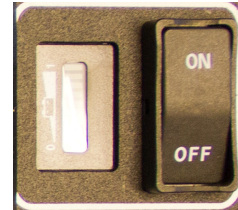

Trackball

The trackball and buttons **G** are a good option if you are wearing gloves or don't want to touch the screen. Use them as a normal mouse and mouse buttons.



User interface

ACU control is the software installed on the ACU which operates the ACS500 system.

- *Menu bar* on page 37
- *System Status* on page 38
- *Battery status* on page 38
- *Sensor Input* on page 39
- *More Status* on page 39
- *Help* on page 40
- *Subsea Telemetry Power* on page 40
- *Execute* on page 40
- *SCU Solenoid Information* on page 40
- *Exit* on page 40

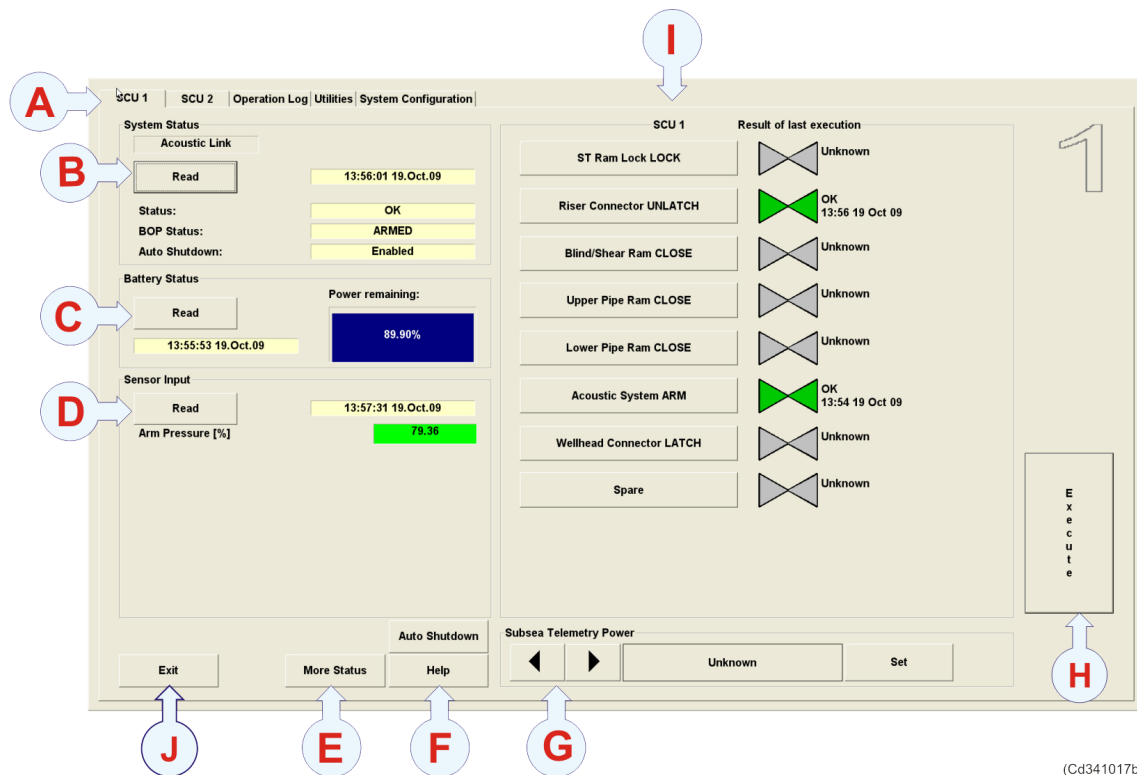

- A** Menu bar
- B** System Status
- C** Battery Status
- D** Sensor Input
- E** More Status
- F** Help
- G** Subsea Telemetry Power
- H** Execute

I SCU Solenoid Information

J Exit

This turns the computer off, use the **Power** button to shut down the complete system.

Menu bar

- SCU 1 and SCU 2 are the operational menus for the two Subsea Command Units and are explained in detail in *Operational procedures* on page 41.
- Operation Log is where all commands and replies are logged. The Operation Log is common for both SCU's.

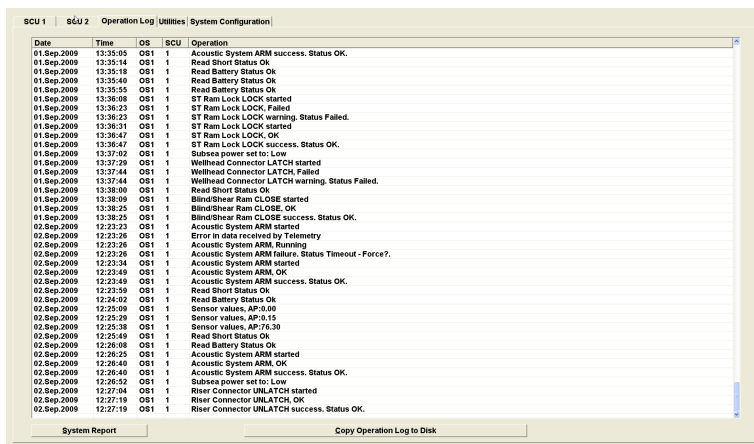

- Utilities is only visible to service engineers.



- System Configuration is where you can configure the different options in your system.

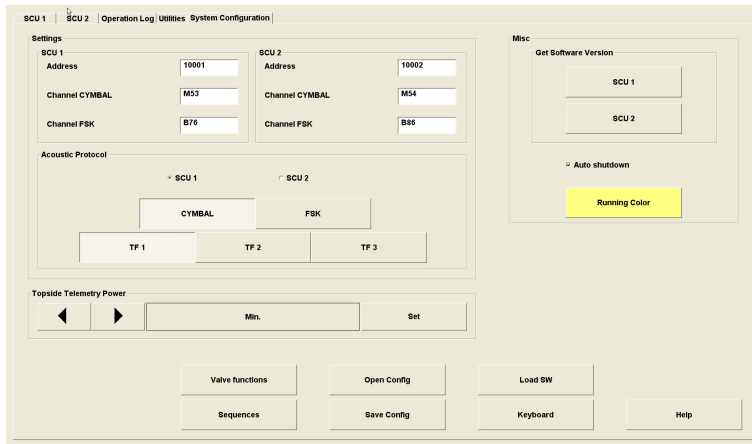

System Status

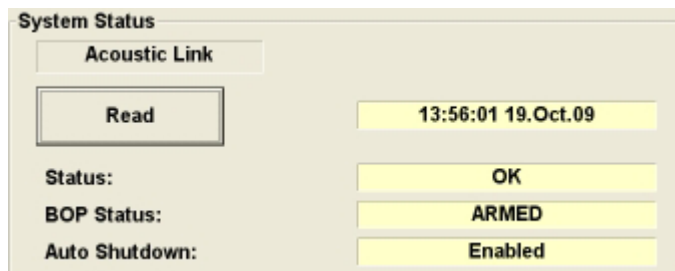

Tap **Read** to see the system status. It is important to know the status of the system before executing any commands.

Battery status

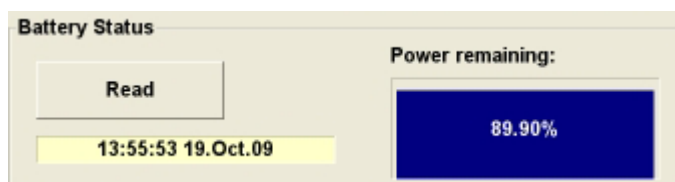

Tap **Read** to see the battery status of the Subsea Command Unit.

Sensor Input

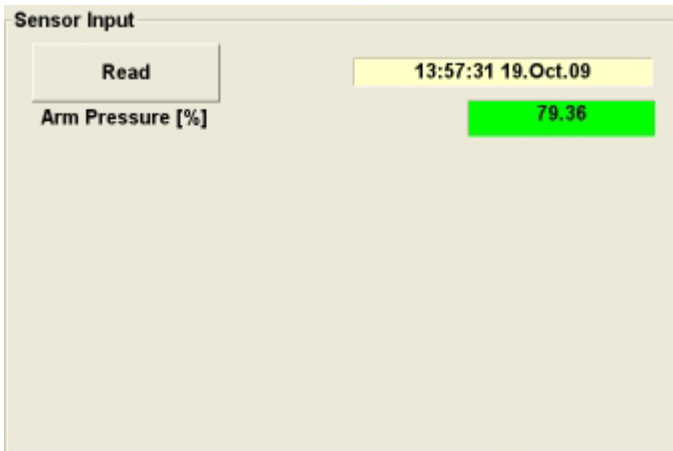

Tap **Read** to get new readings from the sensors. The time of the reading comes up and the colour of the field indicates if the values are within the set parameters.

Alarm conditions are shown in red and a dialogue comes up with the alarm details.

More Status

Tap **More Status** to get options for Readback status, Read last solenoid currents and time.

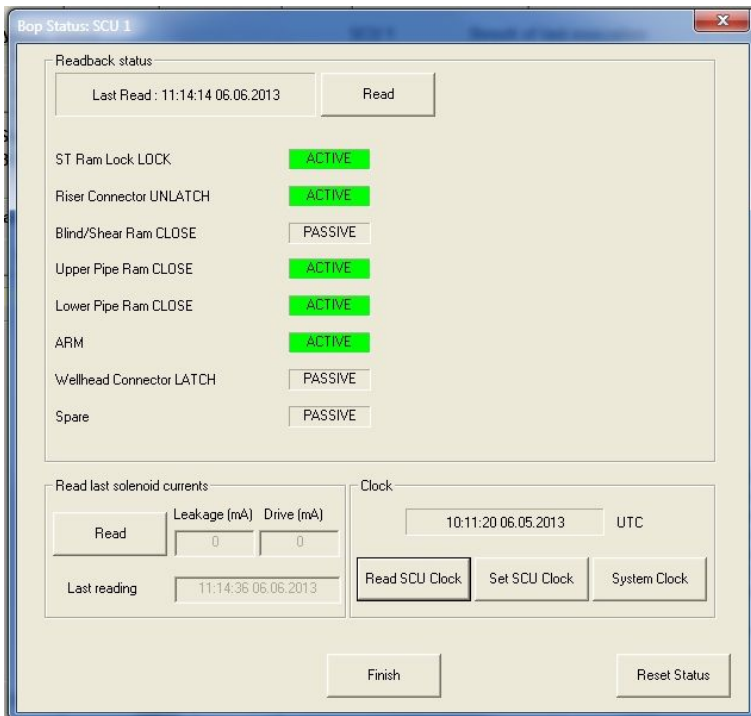

Help

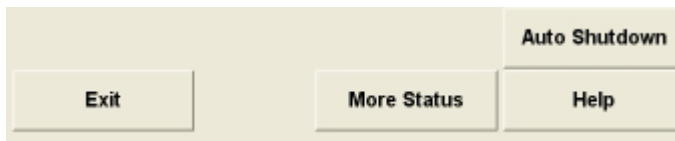

Tap **Help** to open the online help function.

The **Help** button is available on every page and displays relevant information about the current operation.

Subsea Telemetry Power

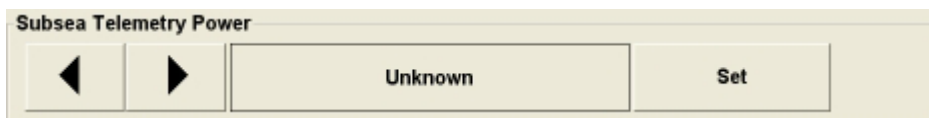

Tap the arrows to select the Subsea Command Units power setting.

Choose between Minimum, Low, High and Maximum.

Tap **Set** to confirm the setting.

Execute

Execute is used for valve operation and in the two hands two buttons emergency system.

SCU Solenoid Information

This section shows the names of the solenoid configuration.

Note _____

This information might be on two pages.

Exit

Tap **Exit** to turn off the computer.

Caution _____

*Turn the system off with the **Power** button as well, as the rest of the system will drain the batteries.*

Operational procedures

This chapter contains the operational procedures explaining how you can put your ACS500 to use.

The menu, operation principles and related information are described in the online help.

Topics

- *Valve operation* on page 41
- *Battery level* on page 43
- *User settings* on page 44
- *System status* on page 46
- *Emergency sequence* on page 48
- *Operating ACS500 from HiPAP (optional)* on page 48
- *Auto Shutdown (option)* on page 49
- *Messages* on page 53

Valve operation

Purpose

This procedure shows how to start up the subsea system.

The system is delivered with the batteries separate as a safety precaution.

Procedure

- 1 Select the tab with the SCU you want to use.
- 2 Test if there is communication between the surface and the subsea system.
In the **Battery Status** section, tap **Read**.
See *Checking communication between the Acoustic Command Unit and the Subsea Control Unit* on page 46.
- 3 In the **SCU Solenoid Information** section, tap the function you want to execute.
- 4 Press **Execute, F** on the left side of the ACU and tap **Execute, N** on the touch screen at the same time.

- 5 Observe the colour and text of the valve symbol to see if the operation was successful.
- Green – The valve operation is done.
 - Dark green – The valve operation is done, and the system has sent a warning, the warning is displayed by the valve symbol.
Low battery or **High currents** are examples of warnings.
 - Red – An error happened during the valve operation. The error message is displayed by the valve symbol.
See *Messages* on page 53 for examples.

Battery level

This section explains how to find the battery levels on the system.

- *Battery status, Acoustic Command Unit* on page 43
- *Battery status, Subsea Control Unit* on page 43
- *External battery capacity* on page 43

Battery status, Acoustic Command Unit

Purpose

This procedure helps you find the battery level of the ACU.

Procedure

- 1 The battery indicator is located on the right side of the ACU. The LED lights green for a fully charged battery, orange for half full and red when the battery is almost empty.

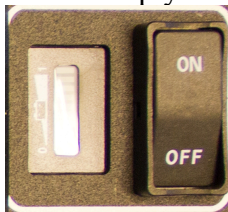

See *Acoustic Command Unit* on page 32.

Battery status, Subsea Control Unit

Purpose

This procedure helps you find the battery level of the SCU.

Procedure

- 1 In the ACU tap the tab of the SCU you want to find the battery level of.
- 2 Tap **Read** in the **Battery status** field.
See *Battery status* on page 38.
- 3 When the remaining power drops below 20% the indicator turns yellow. The SCU is still functioning and a battery change will be necessary soon.
When the remaining power drops below 10% the indicator turns red. Change the battery to ensure uninterrupted operation.

See *Changing the battery on the Subsea Control Unit* on page 79

External battery capacity

Purpose

This procedure helps you find the battery level of the external batteries.

Procedure

- 1 If the SCU is connected to external batteries, the percentages where the battery indicator changes colour should be divided by the total number of batteries.

Number of external batteries	Yellow level	Red level
0	20 %	10 %
1	10 %	5 %
2	7 %	3 %
3	5 %	2.5 %
4	4 %	2 %

User settings

This section shows how to change the power levels for the units and how to change the acoustic protocols.

- *Setting the telemetry power level for the ACU on page 44*
- *Setting the telemetry power level for the Subsea Control Unit on page 45*
- *Changing between Cymbal and FSK on page 45*

Setting the telemetry power level for the ACU

Purpose

This procedure explains how to change the power level for the ACU.

Procedure

You should always first try the default setting before changing the power level.

If it is needed try to increase the power level one step at a time before sending a new command to the SCU.

Caution

*When using the **Maximum** power level, the dunking transducer must be connected and deployed in the sea. This to minimize the risk for electronic and transducer damage at this power level.*

In some cases lower power level may be a better option due to the available acoustic conditions.

- 1 Select the **System configuration** tab.
- 2 In the **Topside Telemetry Power** section, use the arrows to select the setting you want.



- 3 Tap **Set** to confirm the setting.

Setting the telemetry power level for the Subsea Control Unit

Purpose

This procedure explains how to change the power level for the SCU.

Procedure

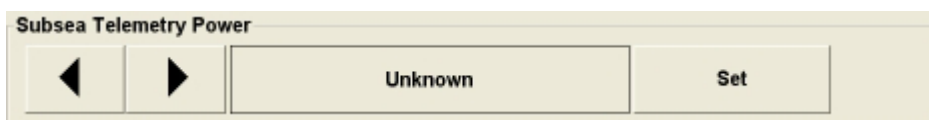

In some cases lower power level may be a better option due to the current available acoustic conditions.

- 1 Select the tab for the SCU you want to change the power level on.
- 2 In the **Subsea Telemetry Power** section, use the arrows to change the power setting.
- 3 Tap **Set** to confirm the setting.
- 4 A telemetry dialogue will come up and show if the power level is changed.

Changing between Cymbal and FSK

Purpose

This procedure explains how to change the acoustic mode used.

Procedure

- 1 Select the **System configuration** tab.

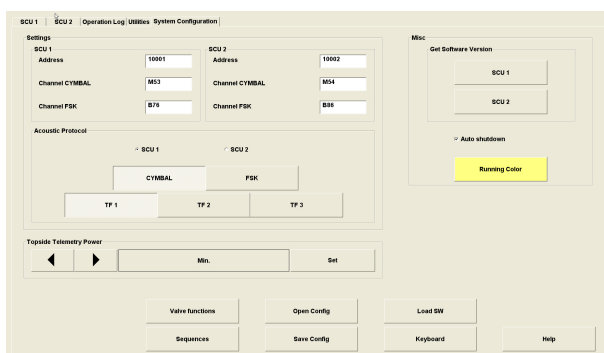

- 2 In the **Acoustic Protocol** section, select the SCU you want to change.
- 3 In the **Acoustic Protocol** section, tap the acoustic mode you want.
- 4 Confirm the message you receive for the change to take place.

System status

The following section shows how to find different aspects of the system status.

- *Checking communication between the Acoustic Command Unit and the Subsea Control Unit* on page 46
- *Reading the system status information* on page 46
- *Reading the sensor input* on page 47
- *Reading the software versions* on page 47

Checking communication between the Acoustic Command Unit and the Subsea Control Unit

Purpose

This procedure explains how to check if there is communication between the surface system and the subsea system.

Procedure

- 1 In the **Battery Status** section, tap **Read**.
- 2 Wait for reply from the SCU. If no response, try three times before continuing with the next step. If you have communication, continue with normal valve operations.
- 3 Increase the power setting with one step at the time on both the ACU and the SCU.
See [Setting the telemetry power level for the ACU](#) on page 44 and [Setting the telemetry power level for the Subsea Control Unit](#) on page 45.
Check the communication by reading the battery status between each step. If no response, try three times before continuing with the next step. If you have communication, continue with normal valve operations.
- 4 Try the alternative SCU. Go back to lower power setting before you start. If no response, try three times before continuing with the next step. If you have communication, continue with normal valve operations.
- 5 Try the same steps with the alternative acoustic protocol and always start with a lower setting both on the ACU and the SCU.
See [Changing between Cymbal and FSK](#) on page 45.

Reading the system status information

Purpose

This procedure explains how to read the system status information.

Procedure

- 1 Select the tab for the SCU you want to see.
- 2 In the **System Status** section, tap **Read**.

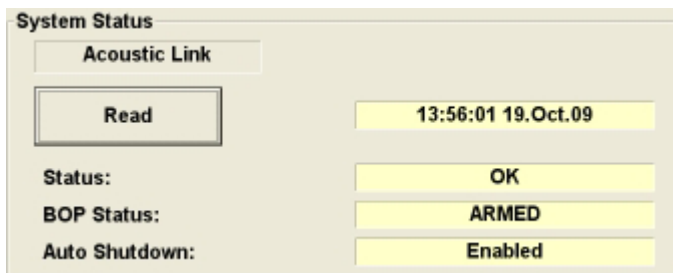

- 3 Wait for reply from the SCU.

Reading the sensor input

Purpose

This procedure explains how to read the sensor input.

Procedure

- 1 Select the tab for the SCU you want to see.
- 2 In the **Sensor Input** section, tap **Read**.
- 3 Wait for reply from the SCU.

All defined sensors are checked and listed. When the values are within the predefined parameters the slot is green. When the values are outside the limits you receive an alarm message.

Reading the software versions

Purpose

This procedure explains how to read the software versions in the system.

Procedure

- 1 Select the **System Configuration** tab.
- 2 In the **Get Software Version** section, in the **Misc** section, tap the SCU you want to know the software version of.



- 3 Wait for reply from the SCU.

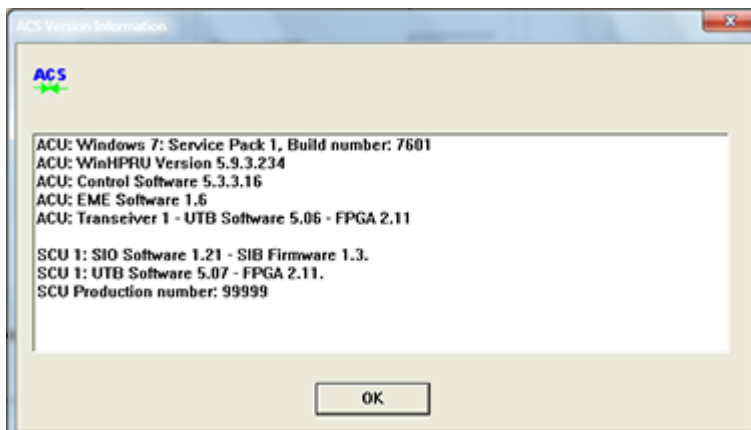

Emergency sequence

The emergency sequence is a redundant operator function for emergencies. With two hands on two buttons you close the predefined valves. The emergency sequence must be predefined in the system to work. See your Registration form for your settings.

The emergency sequence only works from the ACU30, not from HiPAP or HPR.

Purpose

This procedure explains how to perform an emergency sequence, if an emergency sequence is configured. This is a predefined sequence that can be performed in the event of Windows not working.

Procedure

- 1 Unscrew the button on the emergency button cover, **E**.
- 2 Observe the LEDs inside, if the **Run** LED is red you have an error. The emergency system is not available, try restarting the system. The **Finished** LED will be green for 15 sec. When both LEDs are off, continue.
- 3 Press **Emergency**, **E** and **Execute**, **F** simultaneously for five seconds to start the emergency sequence.
If the buttons are released within five seconds, the sequence is not started.
- 4 When the LEDs are green, the predefined sequence is executed.

Operating ACS500 from HiPAP (optional)

Purpose

This procedure explains how to operate ACS500 from HiPAP.

Procedure

- 1 Start **APOS** on the Operator Station.
- 2 Select **Control** in the top menu.
- 3 Select **ACS500**.

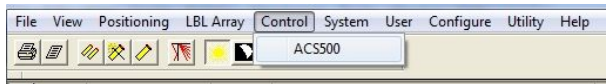

- 4 The ACS500 interface is the same as on the ACU.

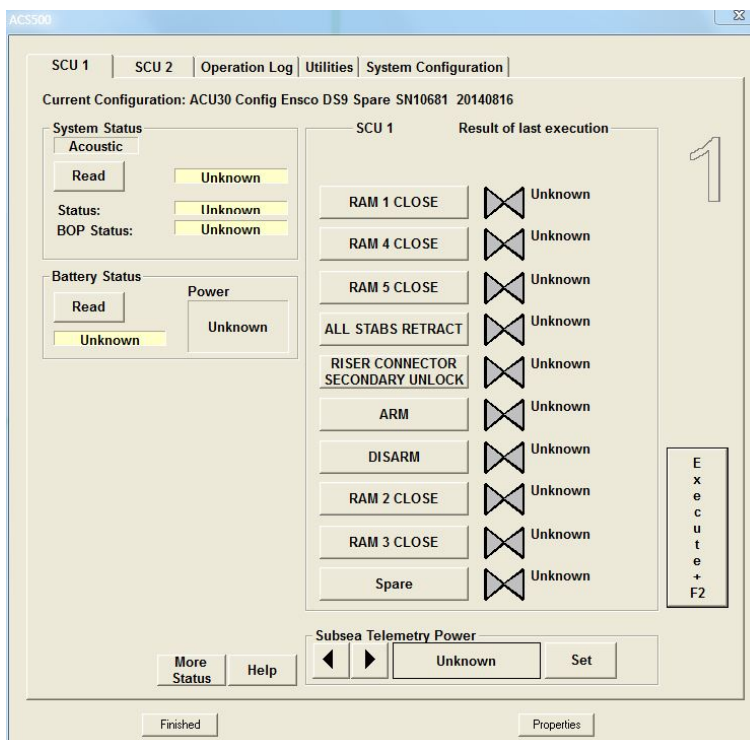

- 5 Notice that on the computer the two hand operation method is to click **Execute** and pressing **F2**.
- 6 Click **Finished** to close the session.

Auto Shutdown (option)

The Auto Shut Down system is a predefined automated shutdown sequence. When the sensors are in a predefined state, the system will close the predefined valves in a predefined sequence. The Auto Shut Down must be predefined in the system. See your Registration form for your settings.

The Auto Shut Down must be enabled to work.

- *Valves used in the sequence* on page 50
- *Sequence operation and timing* on page 50
- *Enabling/Disabling Auto Shutdown* on page 50

Valves used in the sequence

Ordinary defined single valve operations may be put together to a predefined sequence of valve operation in order to perform a controlled shutdown of a system.

This specific sequence must be defined by the customer and predefined in the ACS500 system parameter set.

Sequence operation and timing

The auto shutdown sensors (minimum 1, maximum 3 sensors) are connected to the two available SCU's. It is possible to define different criteria for auto shutdown triggering from the sensors. Both the SCU's will receive the same triggering signal simultaneously. In order to control the valve operation, by sending current to a specific solenoid only from one SCU at a time. The programmed sequence operation may then be performed as illustrated below.

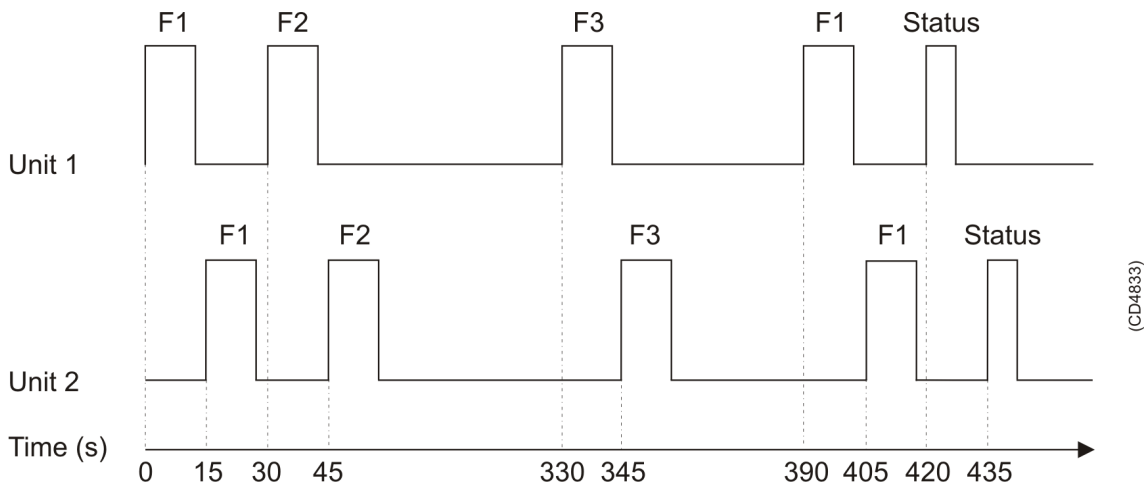

The sequence in the example with 4 single valve operations will be executed directly after triggering from the sensors from SCU 1. The SCU 2 will perform a defined delay before starting the ASHD valve sequence, trying to avoid that the SCU's are sending current to one solenoid at the same time.

- When an ASHD operation is performed, the main priority is subsea at the SCU's in order to control the valve package.
- If an ACU operator tries to control and communicate with the SCU in ASHD time slot, a possible status reply from a SCU will only inform the operator that an ASHD sequence is performing or has occurred.

It will be possible to read a specific ASHD status info telegram when the ASHD sequence is finished. An ASHD sequence will be executed once, and then it is required to enable the function from the ACU if it is to be run a second time.

Enabling/Disabling Auto Shutdown

The ASHD system can only be configured by KM personnel.

See your registration form for your ASHD specification.

Note

The ASHD function must be disabled before recovering the BOP to the deck.

The interface cables must not be connected or disconnected while the ASHD function is enabled.

The main window in the ACU will display information about the Auto Shutdown status.

The status window will either show Auto Shutdown as Enabled or Disabled.



When enabling ASHD always read System Status to get updated information of the Auto Shutdown status.

To enable auto shutdown, tap the **Enable ASHD** button. To disable auto shutdown, tap the **Disable ASHD** button.

Tap **Acknowledge** to confirm you want to enable auto shutdown

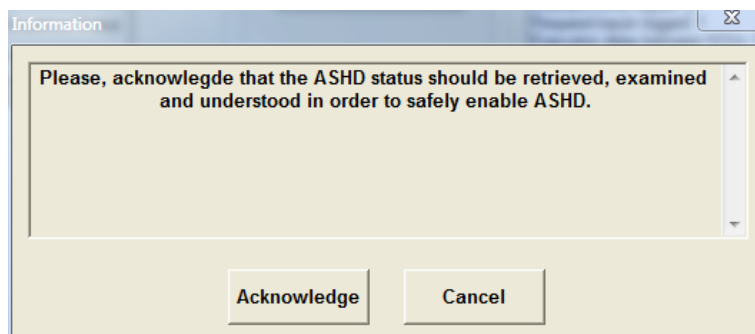

Tap **Read ASHD Trig Status** to get information of the last auto shutdown and the state of the switches.

Read Sequence Status shows the results of an ASHD operation.

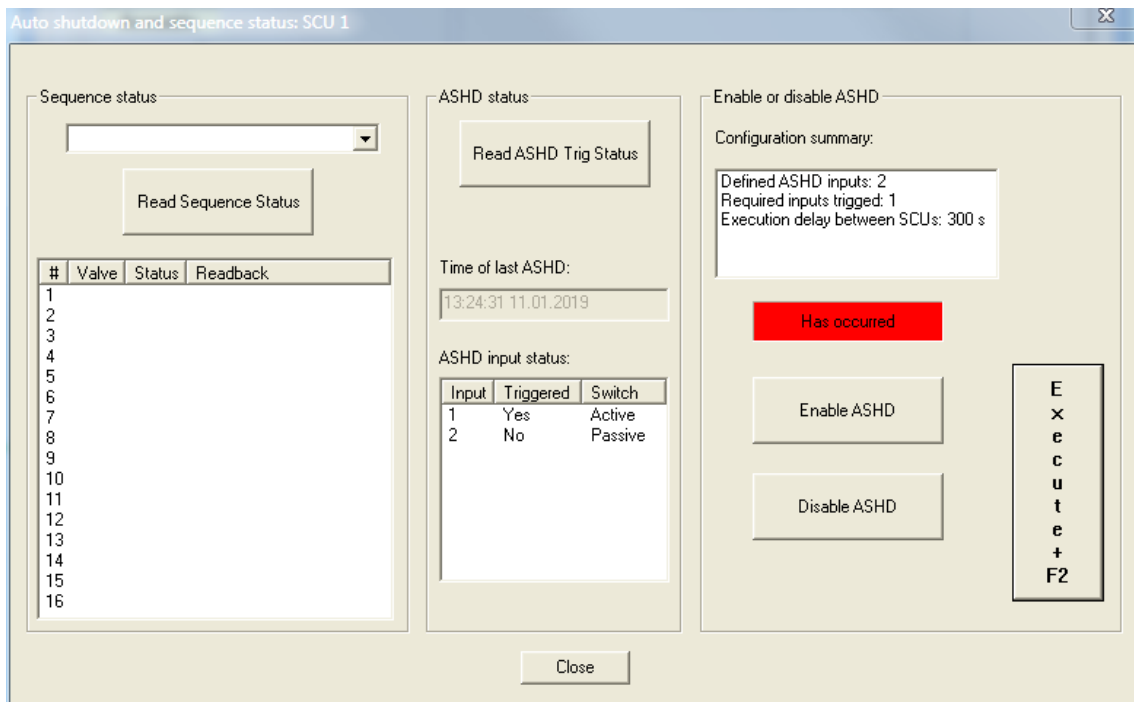

Messages

This section gives some tips when something unexpected happens.

- *No response from SCU* on page 53
- *Link status* on page 53
- *System status* on page 54
- *Link status* on page 53
- *BOP status* on page 55
- *Battery status* on page 56
- *Sensor input* on page 56
- *More status* on page 57
- *Valve operation messages* on page 57
- *Case 1; The valve package is not in Arm mode* on page 61
- *Case 2; Trying to activate a valve function twice* on page 63
- *Case 3; Getting no status reply after execution of a valve* on page 64
- *Case 4; Trying to activate the Arm function twice* on page 65
- *Case 5; Executing a Disarm function when a valve function is still active* on page 65

No response from SCU

The SCU gives no or incorrect response:

Check if the correct SCU is activated. Alternatively: Check the **System Configuration** information.

Link status

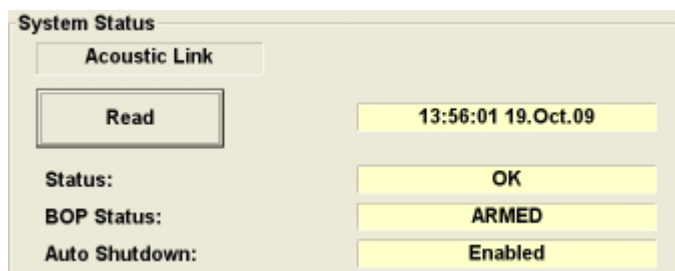

Acoustic link – Normal operation

Serial link (yellow) – Test/service operation only, Configure the ACU correctly in the **Utilities** menu. (Service operation).

Error (red) – ACU Control software failure, Reset the ACU by turning the power off and on. If the system still is faulty, service is needed.

System status

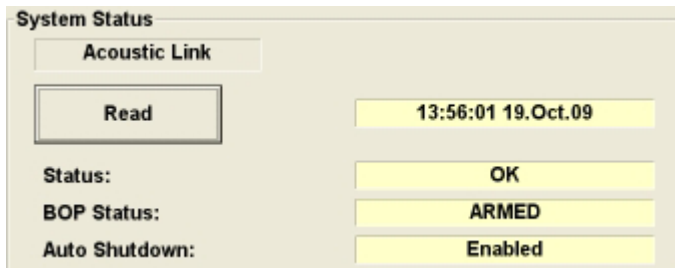

Unknown – Read System Status, see *Reading the system status information* on page 46.

OK – Normal operation.

Telemetry failed, last telemetry command was not confirmed OK from the SCU – Check the connection to the transducer and repeat the telemetry function. See *Checking communication between the Acoustic Command Unit and the Subsea Control Unit* on page 46.

VALVE ERROR (Red background)

Caution

The SCU is DISARMED, Other Valve(s) is/are still Active (Open).

– Check Valve readbacks in the **More Status** menu.

Caution

A new ARM Command may trigger an active valve directly! (Check for sensor failure?!)

Analogue sensor error, detected SCU error bit message regarding Analogue Sensor connection – Check the SCU/BOP Interface and Sensor.

Current < low limit, valve operated OK, measured current lower than defined limit. –

Caution

Repeat readings. Check Sensor and configuration values. In More Status, try to read last Solenoid Currents.

Current > high limit, valve operated OK, measured current higher than defined limit. –

Caution

Repeat readings. Check Sensor and configuration values. In More Status, try to read last Solenoid Currents.

Sequence aborted, ongoing sequence of valve operations in the SCU are confirmed **aborted** – Read System Status in order to check valve status form BOP. Repeat the sequence if needed.

Sequence already executing – A Valve sequence is already performing. Wait for status from SCU.

Automatic shutdown, Optional function. This should not be displayed when function is not available. – Check configuration settings.

SW watchdog, error bit from the SCU regarding software watchdog operation. – Wait 1 minute to power down the SCU and perform a Read System Status operation. Check if the error messages are still present. Report incident for a possible service operation.

Low battery, warning bit from SCU. – Perform a normal % Read battery command status in order to decide the remaining battery capacity of the SCU battery. When a single battery has less than 20 % capacity left, a yellow background in % window is shown. It is time to plan for a battery change. When the window is red it is less than 10% remaining capacity. Change battery when it is possible, alternatively try to operate on the other SCU unit if this battery has a higher remaining capacity.

Current leakage, If this error message is displayed, then the SCU is not allowed to perform a Valve operation towards the solenoids. . – Try to read the actual current value in More Status. Check battery status. If possible check the other SCU unit. Possible failure could be caused by water leakage of different kinds. **SERVICE may be required!**

Current overflow, Error detected, Valve operation will not be performed correctly. Solenoid current drive will be stopped in order not to damage electronics and solenoids. – Try to Read actual current value in More Status. Check battery status. If possible check the other SCU unit. Possible failure could be caused by water leakage of different kinds. **SERVICE may be Required!**

Parameter CRC, Software CRC check in SCU indicates that the SCU is not properly configured. – The SCU should be configured properly and tested on deck by using a BOP Simulator. Service personnel assistance is required.

BOP status

The screenshot shows a 'System Status' window with the following elements:

- A button labeled 'Acoustic Link' at the top.
- A 'Read' button on the left and a timestamp '13:56:01 19.Oct.09' on the right.
- A 'Status:' label with a value of 'OK'.
- A 'BOP Status:' label with a value of 'ARMED'.
- An 'Auto Shutdown:' label with a value of 'Enabled'.

Unknown, status not available – Read System Status, see *Reading the system status information* on page 46.

ARMED, SCU read back shows BOP is ARMED – Check if this is the expected status of the BOP.

DISARMED, SCU read back shows BOP is DISARMED – Check if this is the expected status of the BOP.

Battery status

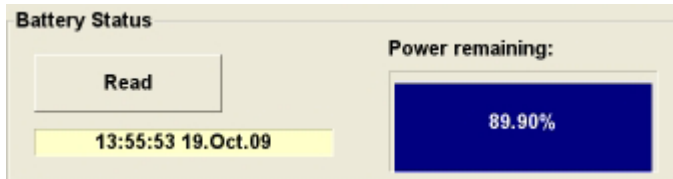

Read SCU remaining battery status capacity [%]. – Yellow background for value below 10 and 20%. Red background indicates less than 10 % remaining battery. Time to change the battery! Alternatively try to use the other SCU Unit, check if this battery capacity is more sufficient until next possible event convenient for battery change.

Sensor input

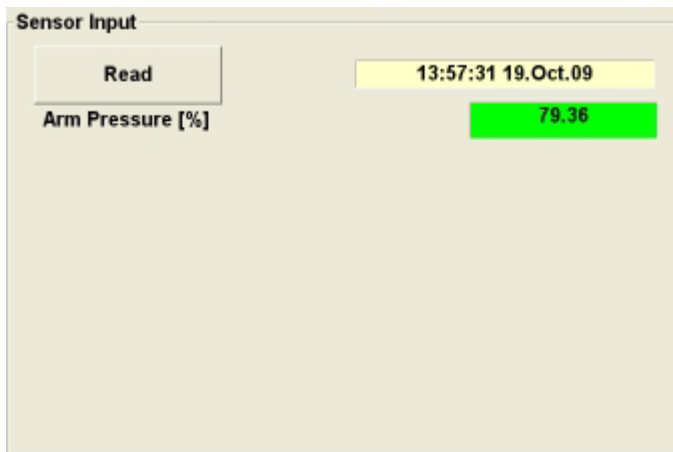

Output values available may be configured in different ways [% , mA, Psi etc..]. Normal current sensor values should be in the area of 4 to 20 mA. The background colour will illustrate OK, Alarm or Error values. – Green is shown for normal values. If an Alarm limit is defined then the Alarm value will be shown with Red background colour. Yellow Warning colour is shown when value is outside the 4 to 20mA area. If value <1 mA, Red colour, then we may have an error with faulty or not connected sensor.

More status

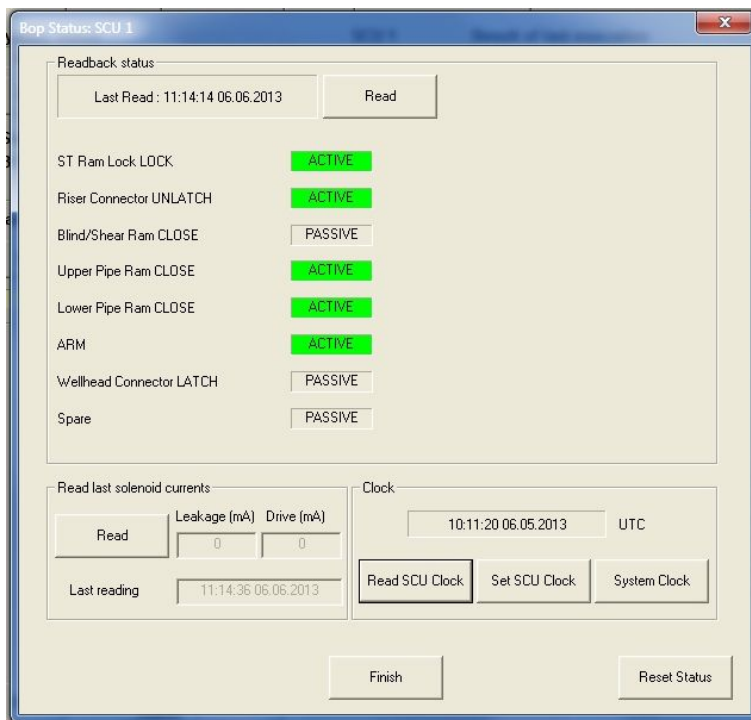

This group of functions is used to show an overview over valve read back status (active/passive) for all defined digital read backs. It is also possible to check real time clock values and the last executed solenoid current and possible leakage value.

Valve operation messages

Message	Description	Action
Press execute buttons	When choosing a Valve function, we get this message in order to proceed in the process.	Press the two Execute buttons in order to perform valve operations.
Running	Confirming ongoing Valve execution process, when receiving command confirmation from SCU.	
OK	Valve operation executed OK, correct read back status confirmed. Solenoid Current measurement within defined limits.	

Message	Description	Action
Failed	Valve operation may be executed correctly. Read back status received is not as expected.	Check details including current values in More Status. Try to repeat operation if possible. Check sensors and configuration values.
High Current	Warning, Dark green colour, this specific operation is OK, but the solenoid current measured is above the defined upper limit. Group B: Status will be updated with a warning message.	Check current reading valve in More status. If the valve is significantly outside the defined scope then check the SCU system.
Low Current	Warning, Dark green colour, this specific operation is OK, but the solenoid current measured is below the defined lower limit. Group B: Status will be updated with a warning message.	Check current reading valve in More status. If the valve is significantly outside the defined scope then check the SCU system.
Unknown	This valve has not been operated yet in the operation window.	
Not armed, Force?	Operation of a normal Valve, when the system is not in ARM mode. Warning to operator.	Continue operation by pressing the Execute buttons for 5 seconds.
Valve already Armed. Executed. Force?	When a Valve is already active (open) then an attempt to execute it twice will give this message.	Continue operation by pressing the Execute buttons for 5 seconds.
Cancelled	When Executing a Valve function and then pressing the Abort button will give this message.	
Timeout-Force?	When starting up a command and not receiving acoustic confirmation from SCU then we get a Timeout warning.	Proceed with ACU Execute message by pressing Execute buttons for 5 seconds. Alternatively, repeat the complete function.

Message	Description	Action
Already armed! Force?	Warning. If the BOP is already Armed, then this message is displayed to the operator.	Continue ARM operation by pressing the Execute buttons for 5 seconds if appropriate.
Already disarmed. Force?	Warning. If the BOP is already Disarmed, then this message is displayed to the operator.	Continue operation by pressing the Execute buttons for 5 seconds.
Valve error?	<p><i>Caution</i> _____</p> <p><i>If a DISARM function is executed and the read back sensors shows that an active (open) Valve is present, then the BOP may be in a dangerous state. Check sensors and Valve status. DO NOT ARM the system before checking out the problem.</i></p>	Possible solution: Repeat the DISARM function in order to reset all Valves.
Not armed Force? (red colour)	Text and colour when main status of SCU has discovered an VALVE ERROR (displayed in Status window, BOP Status: DISARMED)	Read System Status and check details in More Status.
VALVES NOT RESET!!	<p><i>Caution</i> _____</p> <p><i>When the BOP is in DISARM state and a normal Valve is active. Trying to activate ARM function will give this message combined with Status: VALVE ERROR.</i></p>	Check BOP state and sensors. Try to repeat the DISARM function in order to RESET Valve positions/Readback sensors.
Timeout	General message when no final confirmation of a Valve operation is received from the SCU. The Red background colour occurs when Status: VALVE ERROR.	Try to read System Status in More Status. Changes in the SCU/BOP status?

Message	Description	Action
Analogue sensor error	Detected SCU error bit message regarding Analogue Sensor connection.	Check BOP Interface and Sensor.
Sequence aborted	Message to confirm that SCU has stopped the execution of a Valve sequence operation.	
Sequence already executing	<i>Caution</i> _____ <i>A Valve sequence is already ongoing in the SCU.</i>	Wait for status reply from the SCU.
SW Watchdog	Status message bit from SCU. Watchdog event detected.	Check SCU function, if repetition of the message then prepare for service/exchange of unit.
Low battery	Status message bit from SCU. Low battery event detected.	Check Battery status/remaining capacity. If needed then prepare for battery change. If possible use alternative Unit with more battery capacity prior to battery change.
Invalid configuration	SCU error bit, configuration of SCU is not valid.	Check if error is repeating. Service upgrade/configuration and test on deck is required.
Parameter CRC	Error bit from SCU indicating need for SCU configuration process.	Service upgrade/configuration and test on deck is required.

Message	Description	Action
Current leakage	<p><i>Caution</i> _____</p> <p><i>Fatal Error detected. SCU will not execute the Valve function due to current leakage in the system.</i></p> <p>_____</p>	Try to read leakage value in More Status. Check other Valve functions and/or the other SCU Unit. Service/exchange of Unit or interface cabling may be required
Current overflow	<p><i>Caution</i> _____</p> <p><i>Fatal Error detected. SCU will not execute the Valve function due to current overflow in the system, in order to protect the SCU electronics and the solenoids.</i></p> <p>_____</p>	Try to read the last actual current value in More Status. Check other Valve functions and/or the other SCU Unit. Service/exchange of Unit or interface cabling may be required.

Case 1; The valve package is not in **Arm** mode

The valve package is not in **Arm** mode when activating a valve function and has not received OK valve status.

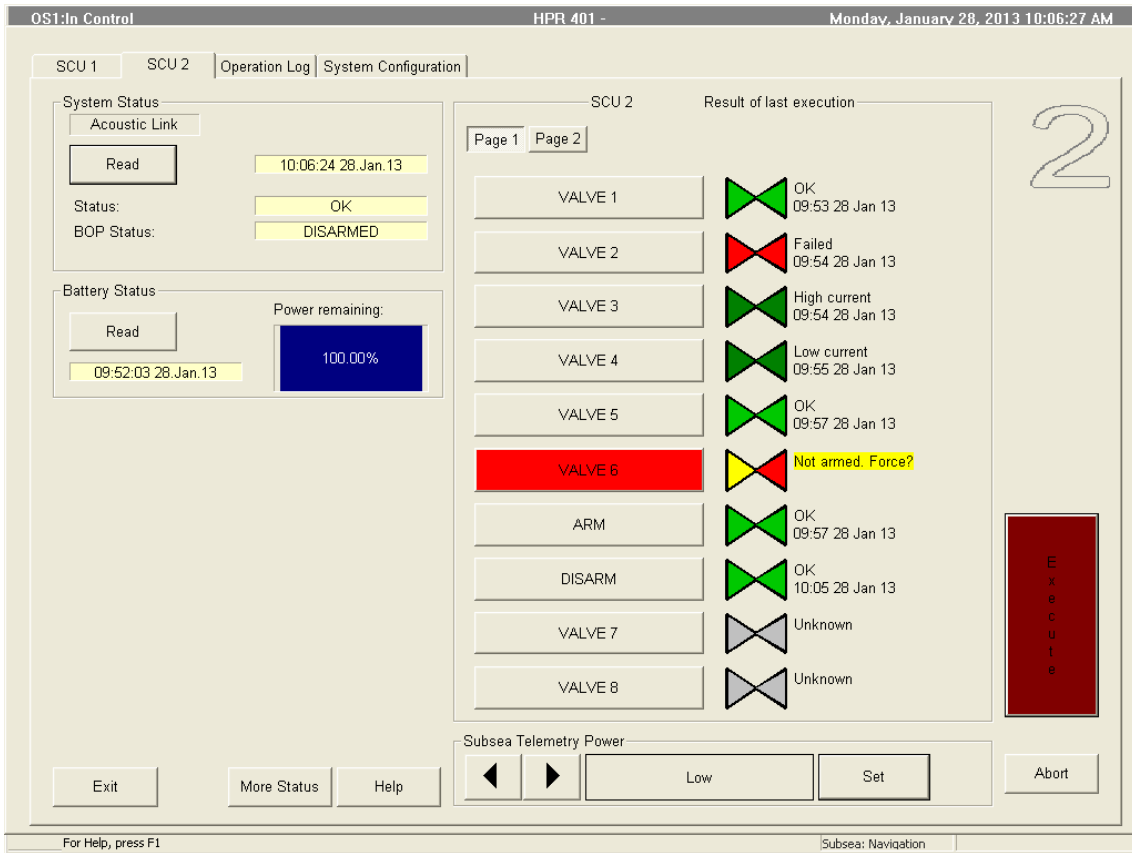

The time stamp shows when an ACS function has been executed.

Valve 1 is the first function that has been executed correctly with an OK readback and current measurement status.

Valve 2 is executed OK, but readback sensor does not confirm OK. Valve status after execution, is sensor OK?

Valve 3 and Valve 4 is executed OK, but current readback value is not within specified window, showing either a Low or High current warning. The actual current value may be checked in the **More Status** menu.

Valve 5, **ARM** and **DISARM** functions were executed OK.

When trying to execute Valve 6 after **DISARM** of the valves, we receive a yellow warning message: "Not Armed. Force?" together with a blinking **Execute** button on the screen. In order to really execute Valve 6, the **ARM** function should be active prior to valve execution. Press and tap both **Execute** buttons to force and continue the Valve 6 operation within 10-15 seconds.

Case 2; Trying to activate a valve function twice

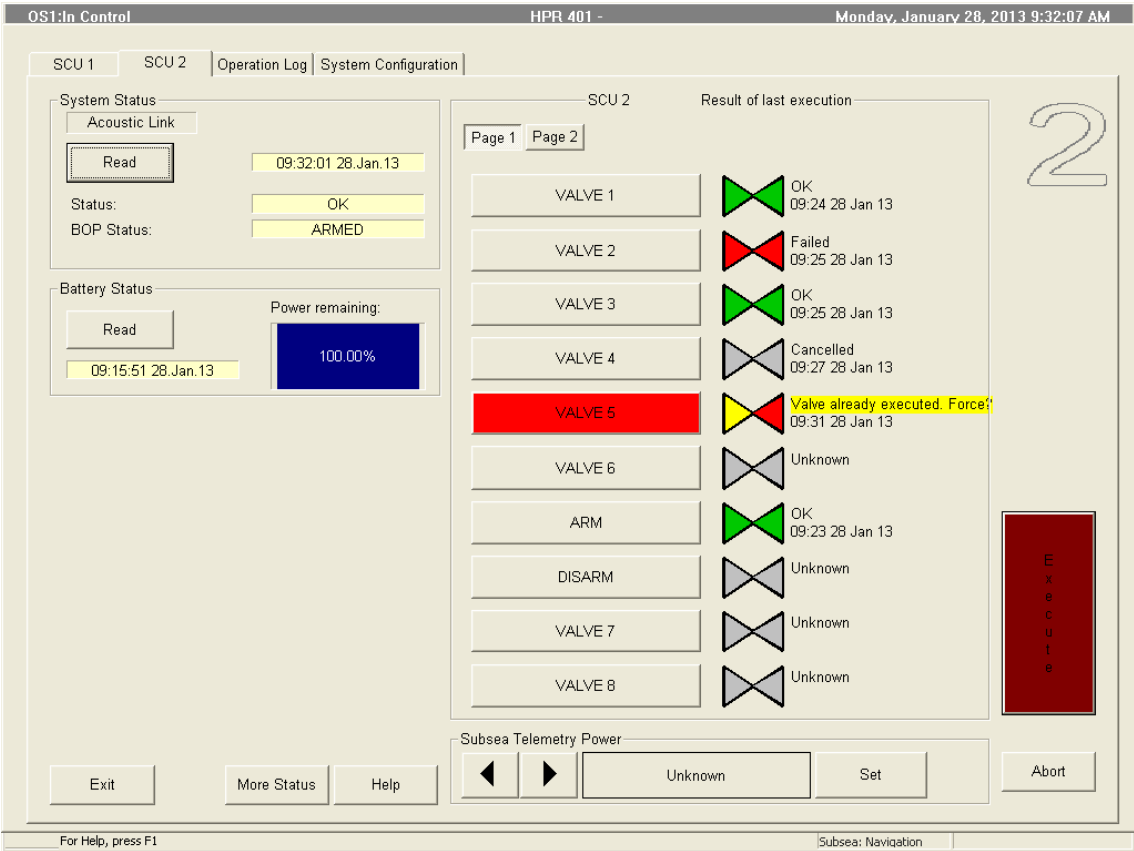

Valve 4 has a "Cancelled" status, this valve is not confirmed executed OK, and no status was received from the SCU.

Valve 5 execution is stopped with a yellow warning "Valve already executed. Force?" This message occurs when the previous status from the readback sensor in the SCU is that Valve 5 is already in active mode. It is still possible to perform the execution once again by pressing the **Execute** buttons a second time (hold buttons for 5 seconds).

Case 3; Getting no status reply after execution of a valve

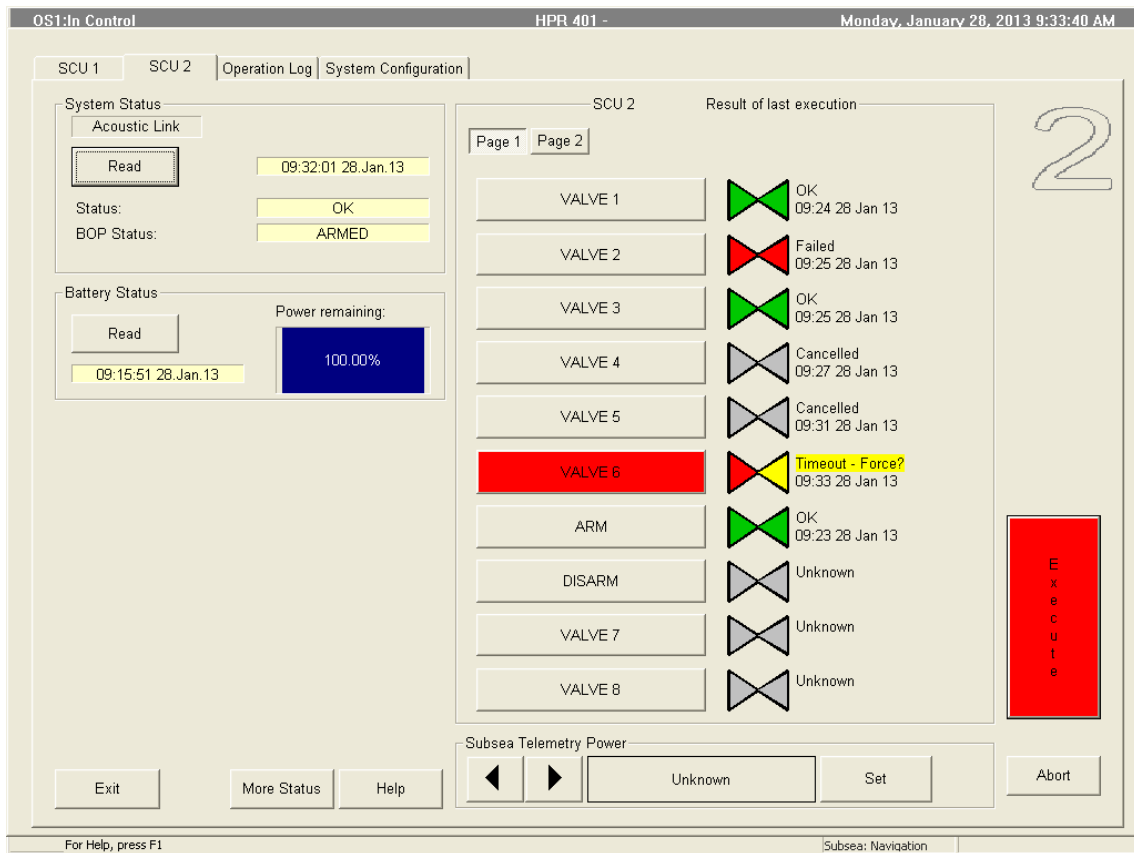

In this figure we are waiting for a missing status reply from the SCU, giving a warning: "Timeout-Force?".

Note

In a critical operational phase we may still try to execute the function (in Cymbal only, regarding timeout window setup values), without receiving any status read back info from the valve/SCU. KM recommends to abort the function and try again, or change to the other SCU, if the situation is not Critical.

Case 4; Trying to activate the **Arm** function twice

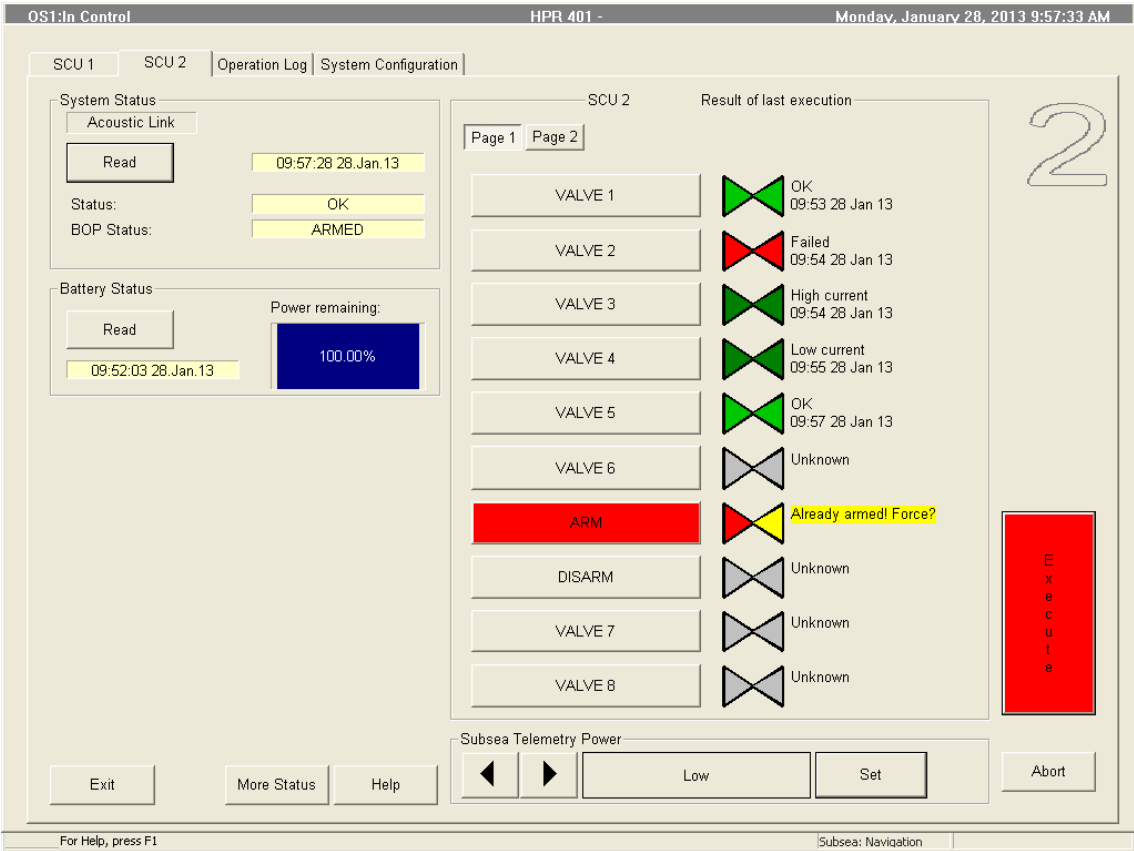

This figure illustrates the case where we try to execute **ARM** when the valve readback sensor indicates that the valve package is already armed. This is only a yellow warning. Press and tap both execute buttons for 5 seconds in order to perform the function.

Case 5; Executing a **Disarm** function when a valve function is still active

Executing a **Disarm** function when a valve function is still active after **Disarm**.

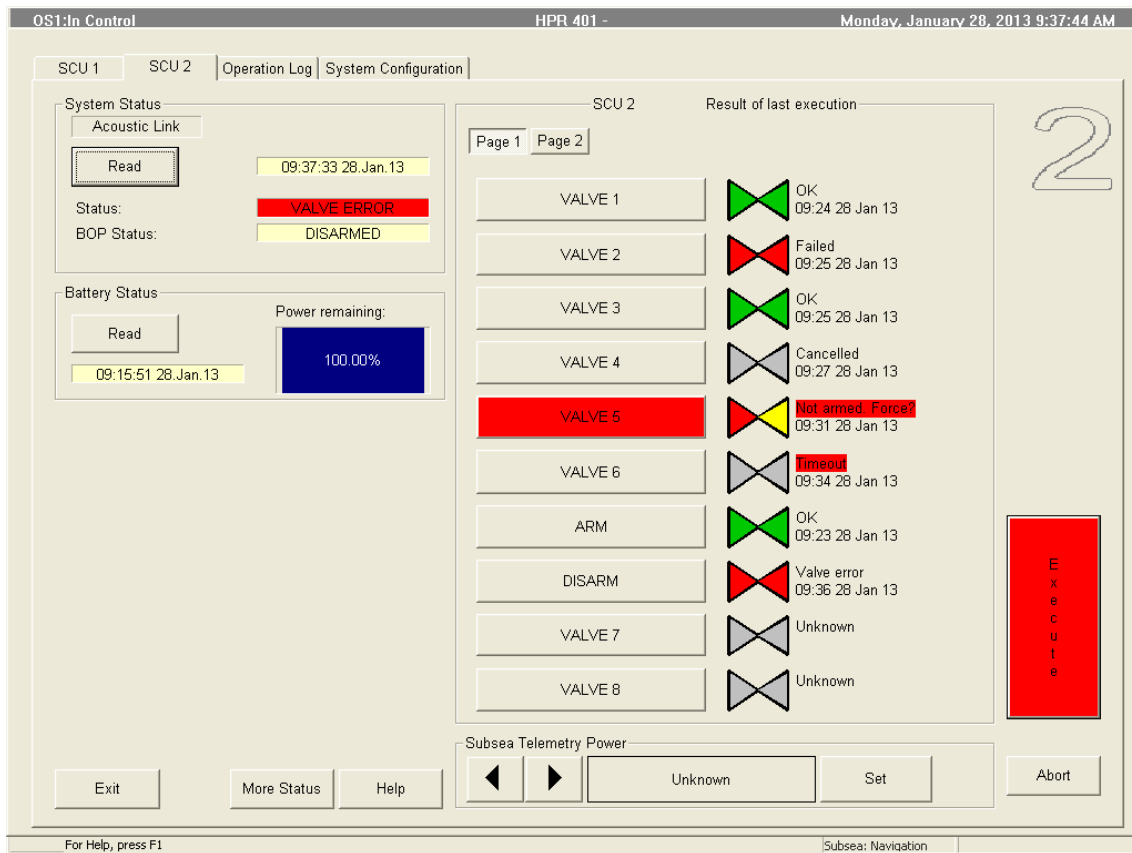

In this figure a possible critical error situation has occurred, giving status "VALVE ERROR". The status in the SCU indicates that the valve package is DISARMED at the same time as other valves are active. Any attempt to execute the ARM function in this situation may cause error due to unwanted execution of the active valves in the system. When trying to execute the DISARM function when ARM sensor is not Active we get a red background for status "Not armed. Force?" on the valve. **DISARM** function execution is possible by pressing and tapping the two **Execute** buttons.

Caution

*The operator should consider the complete valve situation before forcing any execution. Using the **More Status** menu in order to get a better overview over the valve readback situation is recommended.*

Simulation and test

This chapter describes the test procedures for the ACS500 system.

Topics

- *Connecting the test equipment* on page 68
- *Test procedure* on page 69
- *Testing ACS500 with HiPAP* on page 71

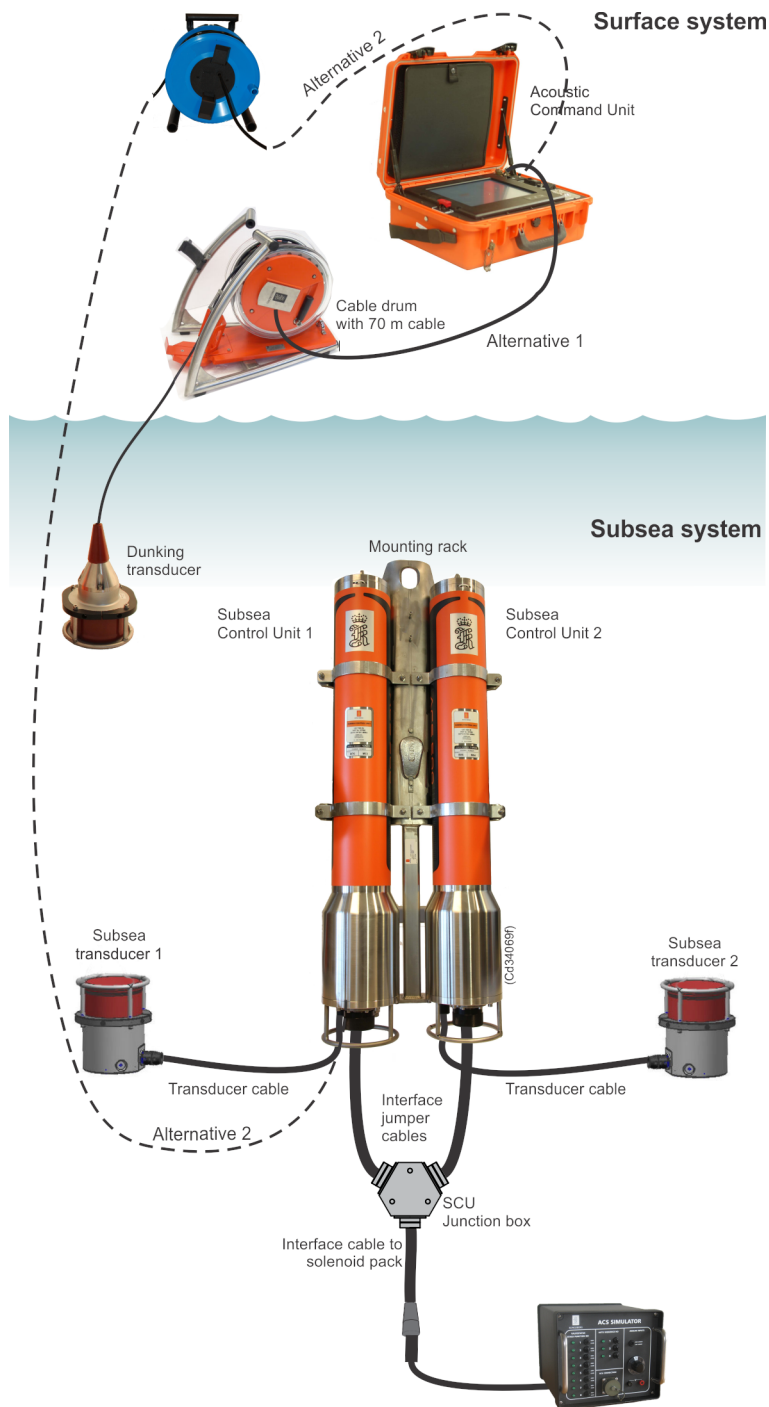

Connecting the test equipment

This section shows the different ways to set up the test equipment.

- *Alternative 1* on page 69
- *Alternative 2 (preferred method)* on page 69

Alternative 1

Alternative 1 may be used for testing in air. The transducers are made for communication in water, so alternative 2 is the preferred method.

Caution

Use **Low** or **Min** telemetry power to avoid damaging the transducers when communicating in air.

See *Setting the telemetry power level for the ACU* on page 44 and *Setting the telemetry power level for the Subsea Control Unit* on page 45.

Alternative 2 (preferred method)

Purpose

This procedure shows how to set up the test system.

Procedure

- 1 Disconnect the subsea transducer from the SCU.
- 2 Connect the transducer test cable to the SCU.
- 3 Connect the other end of the transducer test cable to the ACU.
Only **Low** telemetry power is needed when using the transducer test cable.

Test procedure

You use the simulator provided with the ACS500 system to test.

Connect the simulator with the system as described in the previous section. The second alternative is preferred as the transducers are made for communication in water.

Systems with dynamic switches can read the valve status when the solenoid function has been carried out. Systems with static switches can read the valve status at any time.

Purpose

This procedure shows how to test the system.

Procedure

- 1 Establish contact with SCU 1, using the dunking transducer and the ACU by selecting the **SCU 1** tab.
- 2 Test all functions. Start with **DISARM** (if available).
Tap **DISARM**.
- 3 Press **Execute**, tap and hold **Execute** on the touch screen at the same time until the command is executed.

- 4** When the green LED for the valve operation lights up on the simulator (this might take some minutes), wait for a second or two, then toggle the valve switch.

The switch simulates that the hydraulic pilot pressure has opened the slide valve. This should result in a correctly confirmed valve operation.
- 5** When the LED is switched off, check that the correct status message is displayed on the ACU screen. **FAILURE** is displayed if something is wrong.
- 6** Continue with the **ARM** function (if available).

Tap **ARM** and repeat steps 3 to 5.
- 7** Execute all other stack functions from the ACU by tapping the correct function and repeating steps 3 to 5 for all functions.
- 8** Establish contact with SCU 2, using the dunking transducer and the ACU by selecting the **SCU 2** tab.
- 9** Repeat steps 2 to 7 for all stack functions.
- 10** Some systems also have a possibility to read analogue sensors. These can also be tested with the simulator.

The toggle switch will simulate low current, 6 mA or high current, 18 mA readings on the analogue sensor. One of the valve functions has to be operated in order to simulate these values.

Testing ACS500 with HiPAP

Testing the system is also possible using HiPAP.

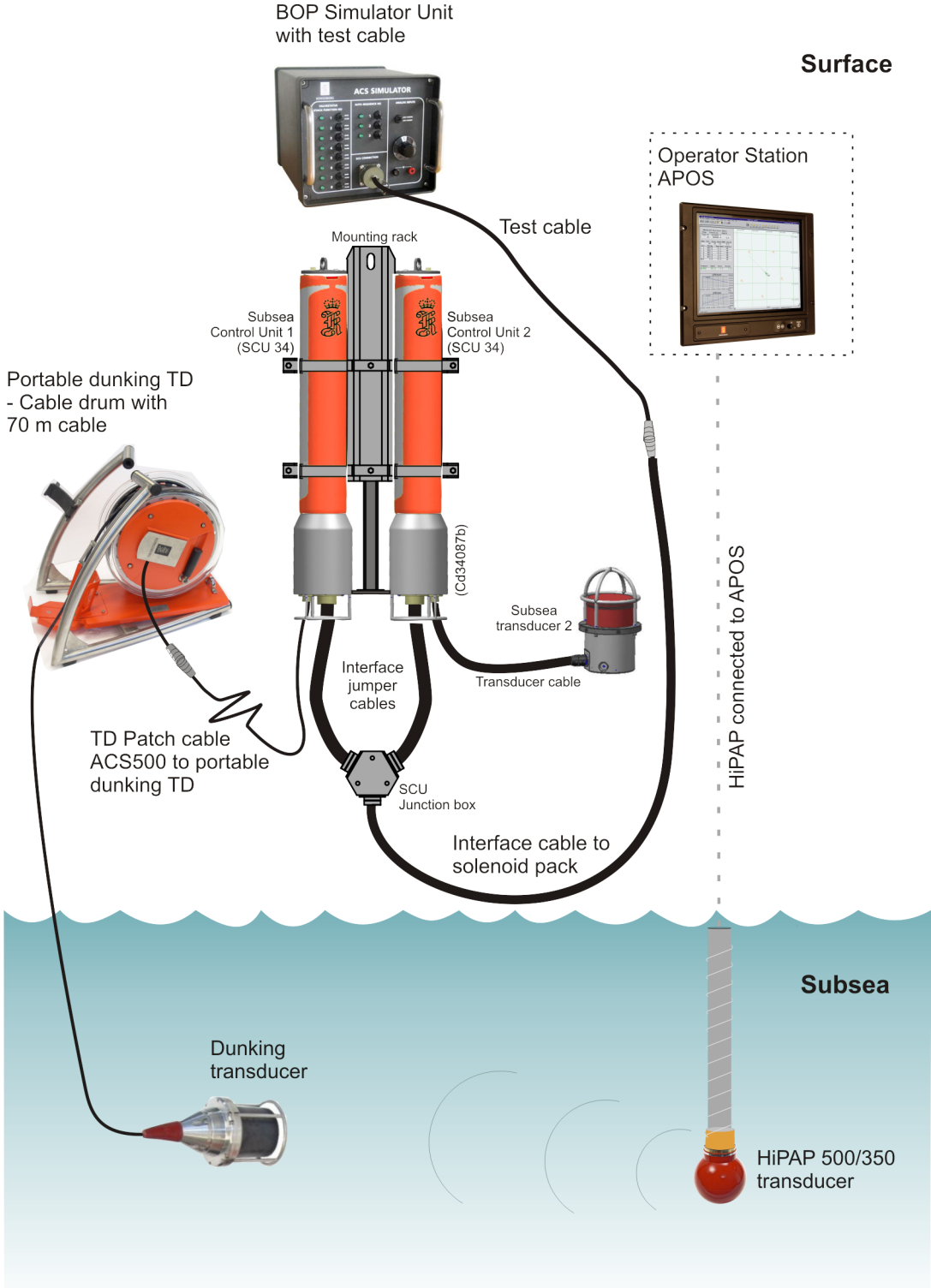

Purpose

This procedure shows how to set up the test system with HiPAP.

Procedure

- 1 Connect the transducer patch cable.
- 2 Lower the dunking transducer into water.

Caution _____

Make sure there are no obstacles between the dunking transducer and the HiPAP transducer.

- 3 Operate the system from APOS via the HiPAP transducer using the same test method as the *Test procedure* on page 69.

Maintenance

This chapter provides maintenance procedures provided for the Kongsberg ACS500. The procedures include relevant maintenance, software and test procedures for the main units.

Note

Major repairs and complete overhaul of the Kongsberg ACS500 can only be done by an authorized Kongsberg Maritime service engineer.

Topics

- *Acoustic Command Unit* on page 74
- *Dunking transducer* on page 76
- *Subsea Control Unit* on page 77
- *External quad battery unit for the Subsea Control Unit.* on page 82
- *Subsea transducer* on page 85
- *Interseal test* on page 87

Acoustic Command Unit

Maintenance on the ACU is mostly keeping the unit charged and clean.

- *Cleaning the Acoustic Command Unit* on page 74
- *Charging the Acoustic Command Unit* on page 74
- *Changing the battery on the Acoustic Command Unit* on page 75

Cleaning the Acoustic Command Unit

Purpose

This procedure explains how to clean the ACU.

Procedure

- 1 Ensure that the ACU is kept clean and dry.
- 2 Remove dust and salt water residue with a soft cloth moistened in fresh water.
Do not use strong solvents.
Dedicated cleaning chemicals for displays are provided by office suppliers.

Charging the Acoustic Command Unit

Purpose

This procedure explains how to charge the ACU.

Procedure



The unit is designed to be kept on charging at all times.

The charger cable is kept in the folder inside the lid.

- 1 It is recommended that the ACU is switched off during long term charging.
- 2 Connect the charger cable to the connector **J** on the front of the case.
- 3 Connect the other end to a 230/115 VAC mains supply.
- 4 A complete recharge of a completely discharged battery takes approximately seven hours.

- 5 If the unit is stored, it is important it is charged every month to keep it ready for operation.

Changing the battery on the Acoustic Command Unit

Purpose

This procedure explains how to change the battery on the ACU.

The rechargeable battery needs to be replaced typically every 10 years. This depends on use and battery maintenance.

Procedure

- 1 Detach the supports on either side of the lid by unscrewing one screw on each side.



- 2 Unscrew 18 screws on the front panel.
- 3 Lift the monitor from the case.
- 4 Unplug all cables to the monitor and the battery.
- 5 Unscrew the 4 screws holding the battery in place.
- 6 Pull the battery towards you and lift it up.

The battery is held in place by 4 metal clips in the bottom of the case.

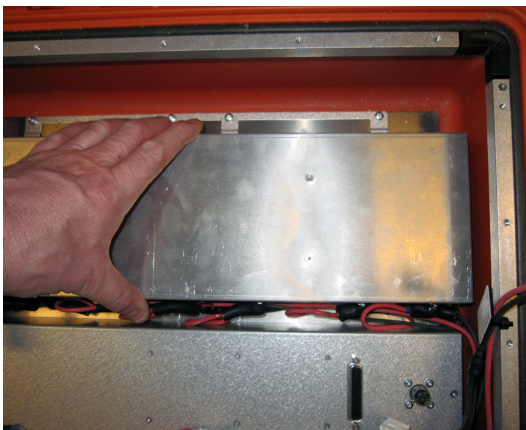

- 7 Insert the new battery and follow the instructions in the reverse order.

Dunking transducer

Maintenance on the dunking transducer is mostly keeping the unit clean and the drum and bearings oiled.

- *Cleaning the dunking transducer* on page 76
- *Checking the dunking transducer* on page 76

Cleaning the dunking transducer

Purpose

This procedure explains how to clean the dunking transducer.

The unit should be cleaned every time it has been deployed.

Procedure

- 1 Clean the transducer, cable and cable drum with fresh water to remove any salt water and dirt.

Caution

Do not use a high pressure hose for this operation as the transducer could be damaged.

Checking the dunking transducer

Purpose

This procedure explains how to check the dunking transducer for defects.

Procedure

- 1 Ensure that the transducer face is clean and free of defects.
- 2 Check that the retaining strap is in good condition and will prevent the transducer from falling out of its holder during transport.
- 3 Check that the connector on the surface end is in good condition and the rubber seal is fitted.
- 4 Ensure that the protective cap is connected to the drum and is fitted to the surface connector when the unit is not in use.
- 5 Put a few drops of oil on the drum and roller bearings, around the winding handle and on the break screw thread. This will help prevent corrosion and ensure trouble-free operation when the unit is required.
- 6 Check the lifting strop and look for cuts, frays and other damage.

Subsea Control Unit

Maintenance on the SCU is mostly changing the battery and checking the seals before the unit is deployed in water.

- *SCU maintenance overview* on page 77
- *Cleaning the Subsea Control Unit* on page 77
- *Opening the Subsea Control Unit* on page 78
- *Changing the battery on the Subsea Control Unit* on page 79
- *Testing the seals on the Subsea Control Unit* on page 80
- *Replace a Subsea Control Unit and duplicate the configuration* on page 81

SCU maintenance overview

Every time the Subsea Control Unit is taken out of the water

- Clean the unit.

Every time the Subsea Control Unit has been opened

- Test the O-ring by using the interseal test port.

Every week/biweekly

- Read SCU battery status.

Every year

- Test all O-rings by using the interseal test ports.

Every 18 months

- According to Kongsberg Maritime's experience, the battery consumption is approx. 3-5% per month during normal operations. Kongsberg Maritime therefore recommends that the battery is changed at least every 18 months.

Cleaning the Subsea Control Unit

Purpose

This procedure explains how to clean the SCU.

Clean the unit before opening it.

Procedure

- 1 Use a wooden or plastic scraper or a stiff brush (not wire) to remove shells and growth.
Be careful not to damage the paint as this leads to corrosion.
- 2 Ensure that all dirt, slime and growth is removed.
- 3 Clean the unit thoroughly with lots of fresh water.

- 4 Dry the unit thoroughly. Dry off any water around the end cap and the vent screw.
- 5 If the unit is not to be dismantled from the valve package before performing maintenance, erect a protective cover over the unit to prevent water and dirt coming inside the unit when the lid is opened.

Opening the Subsea Control Unit

Purpose

This procedure explains how to open the SCU.

Clean and dry the unit thoroughly before opening. Make sure no water or dirt may fall into the unit from above.

Procedure

- 1 The tube and top end cap are held together by a lock cord inserted in a groove between them.

Pull out the lock cord, **A**.

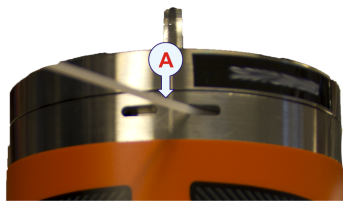

- 2 The lock cord is inserted by hand and removed by picking up the fastening flap and pulling the cord out.

If the cord is stuck it might be an indication of increased pressure inside the unit.

Open the vent screw, **B** for relief.

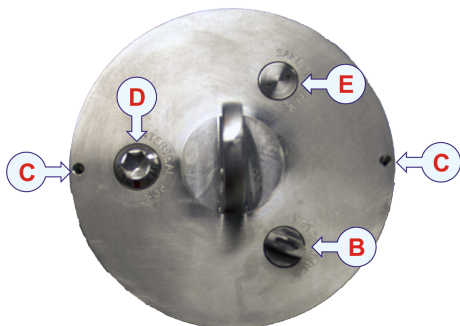

- 3 Pull out the top end cap.

The two M5 screws between the units may be used to push the top up. Insert the screws into the holes, C on the top of the unit and screw until the lid is open.



Put the screws back for later use.

- 4 Remove the top end cap.
- 5 Always perform an interseal test on the test port ,D when the lid has been opened. See *Testing the seal* on page 88.

Changing the battery on the Subsea Control Unit

Purpose

This procedure explains how to change the battery on the SCU.

Read *Lithium batteries safety procedures* on page 127 before handling the batteries.

Procedure

- 1 Open the SCU.
See *Opening the Subsea Control Unit* on page 78.
- 2 Grab the handle and pull out the old battery.

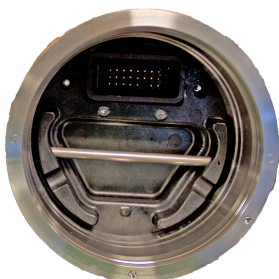

- 3 Insert the new battery.
Inserting the battery at an angle makes it easier.



- 4 Place the top end cap back on.

Observe the alignment marks on the lid and the body of the SCU.

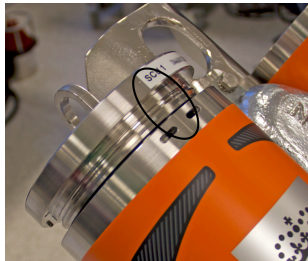

Follow the open procedure in reverse order. See *Opening the Subsea Control Unit* on page 78.

- 5 Clean and screw in the vent screw if it has been opened.
- 6 Replace the lock cord.
- 7 Perform an interseal test for the top end cap on the test port, C.
See *Testing the seal* on page 88.

Testing the seals on the Subsea Control Unit

Purpose

This procedure explains how to identify the interseal test ports to verify that the SCU is properly sealed and watertight.

Related topics

- *Interseal test* on page 87

Important

Before you apply pressure, make sure that all connections are correct, and that all equipment are clean and free from damage.

Do not exceed the maximum test pressure of 11 bar.

Procedure

1

The unit has test ports **C** both in the top end cap and the base. The base is normally not opened. The seal must still be tested every year, to make sure the seal still is functional.

2 To do the actual testing, see *Testing the seal* on page 88



Replace a Subsea Control Unit and duplicate the configuration

Purpose

This procedure explains how to replace an SCU and duplicate the configuration from one SCU to a replacement SCU.

Procedure

Duplicating the configuration from one SCU to another SCU is performed via serial line cable from the ACU to SCU. The rest of the procedure is performed in the ACU system.

- 1 Replace the SCU with a new SCU on the SCU bracket.
- 2 Connect the serial line cable to the connector **A** at the top inside the ACU case.
 - Use serial line cable SL A6 5 G7.
- 3 Connect the signal cable to the connector on the SCU as indicated.
- 4 In the ACU system go to **System configuration** and select **Replace SCU**.

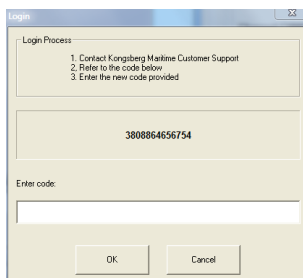

5 A login dialog box will appear on the ACU screen.

- 6 Contact Kongsberg Maritime Customer Support to receive a code for duplicating the configuration of the old SCU to the new SCU.

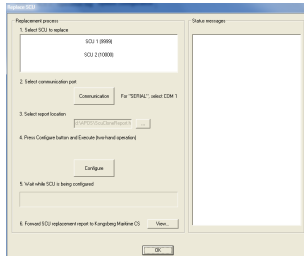

- 7 Refer to the code in the dialog box.
- 8 Enter the new code provided by Kongsberg Maritime Customer Support and select **OK**.
- 9 Select the SCU you want to duplicate in the **Replace SCU** dialog box.
- 10 Select communication port.
- 11 Select report location.
- 12 Select the **Configure** and **Execute** at the same time (this is a two-hand operation).
Wait while the SCU configuration is being duplicated.
Observe the Status messages on the right hand side of the dialog box for updates.
- 13 Select **View** to get the Duplication report.
- 14 Email the Duplication report to Kongsberg Maritime Customer Support.
- 15 Select **OK**.
- 16 The new SCU is now ready for operation.

External quad battery unit for the Subsea Control Unit.

Maintenance on the quad battery unit is mostly changing the battery and checking the seals before the unit is deployed in water.

- *Quad battery maintenance overview* on page 82
- *Cleaning the external quad battery unit* on page 83
- *Opening the external quad battery unit* on page 83
- *Changing the batteries in the external quad battery unit* on page 84

Quad battery maintenance overview

Maintenance on the quad battery unit is mostly changing the battery and checking the seals before the unit is deployed in water.

Every time the battery unit is taken out of the water

- Clean the unit.

Every time the battery unit has been opened

- Test the O-ring by using the interseal test port.

Every year

- Test the O-ring by using the interseal test port at least once a year to make sure the O-ring is still functioning properly.

Cleaning the external quad battery unit

Purpose

This procedure explains how to clean the external quad battery unit.

Clean the unit before opening it.

Procedure

- 1 Use a wooden or plastic scraper or a stiff brush (not wire) to remove shells and growth.
- 2 Ensure that all dirt, slime and growth is removed.
- 3 Clean the unit thoroughly with lots of fresh water.
- 4 Dry the unit thoroughly. Dry off any water around the end cap and the vent screw.
- 5 If the unit is not to be dismantled from the valve package before performing maintenance, erect a protective cover over the unit to prevent water and dirt coming inside the unit when the lid is opened.

Opening the external quad battery unit

Purpose

This procedure explains how to open the external quad battery unit.

Clean and dry the unit thoroughly before opening. Make sure no water or dirt may fall into the unit from above.

Procedure

- 1 Unscrew the 6 screws from the top end cap.



Insert longer M6 screws in the 6 holes, **E** to push open the lid.

If this is difficult, there might be a pressure difference. Open the vent screw, **C** for relief and continue opening the lid.

- 2 Remove the top end cap.
- 3 Always perform an interseal test on the test port **D** when the lid has been opened. See *Testing the seal* on page 88.

Changing the batteries in the external quad battery unit

Purpose

This procedure explains how to change the battery on the external quad battery unit.

Procedure

- 1 Open the external quad battery unit.
See *Opening the external quad battery unit* on page 83.
- 2 Grab the handle, **E** and pull out the old battery.



- 3 Insert the new batteries.
- 4 Place the top end cap back on.

Follow the open procedure in reverse order. See *Opening the external quad battery unit* on page 83.

- 5 Clean and screw in the vent screw if it has been opened.
- 6 Perform an interseal test for the top end cap on the test port, **D**.
See *Testing the seal* on page 88.

Subsea transducer

Maintenance on the subsea transducer is mostly keeping the unit clean.

- *Cleaning the subsea transducer* on page 85
- *Replacing the subsea transducer* on page 85

Cleaning the subsea transducer

Purpose

This procedure explains how to clean the subsea transducer.

Any marine growth on the transducers will degrade the system's operational capabilities. Clean the transducers at every opportunity.

Procedure

- 1 Use a wooden or plastic scraper or a stiff brush (not wire) to remove shells and growth.

Be careful not to damage the coating, as this damages the transducer.

Caution _____

Do not use metal tools, solvents or high-pressure water/steam.

- 2 Ensure that all dirt, slime and growth is removed.
- 3 Clean the unit thoroughly with lots of fresh water.
- 4 Dry the unit and inspect it for damage.

Replacing the subsea transducer

Purpose

This procedure explains how to replace the subsea transducer.

Procedure

- 1 Clean the base of the unit. Make sure all mud and marine growth is removed.
- 2 Dry the area around the transducer cable connector.

- 3 Remove all cable clips and binding securing the transducer cable to the valve package.
- 4 Disconnect the cable connector from the Subsea Control Unit.
- 5 Support the transducer to make sure it doesn't fall when the securing bolts are removed.
- 6 Remove the bolts securing the transducer to the valve package.
- 7 Remove the transducer.
- 8 Lift a new transducer onto the mounting position on the valve package.
- 9 Screw in new bolts of the same type and length as the old ones.

Note

These bolts are not delivered with the transducer as they depend on the thickness and material of the structure they are mounted on.

- 10 Tighten the bolts to the torque recommended by the manufacturer.
- 11 Run the transducer cable to the Subsea Control Unit following the same route as the original cable.
- 12 Secure the cable to the frame at the appropriate positions.
- 13 If necessary, clean the insulators and casing using a stiff brush and water or ethyl alcohol.

Caution

Do not use trichloroethylene, benzene, methylethylketone etc.

- 14 Fill the tapered recesses in the front of the insulator with silicone grease.
- 15 Make the connection and tighten the coupling nut to the torque recommended.

Interseal test

All seals that have been opened should be tested before the unit is deployed in water. The interseal test kit is an optional kit for ACS500.

- *Assemble the test kit on page 87*
- *Testing the seal on page 88*
- *Changing the battery in the Digital pressure indicator on page 89*

- A Inlet for reservoir (not used)
- B Outlet port (connect to Digital pressure indicator)
- C Volume adjuster
- D Limit adjuster
- E Scissor-action handles
- F Outlet port (connect to unit to be tested)
- G Selector valve
- H Pressure relief valve

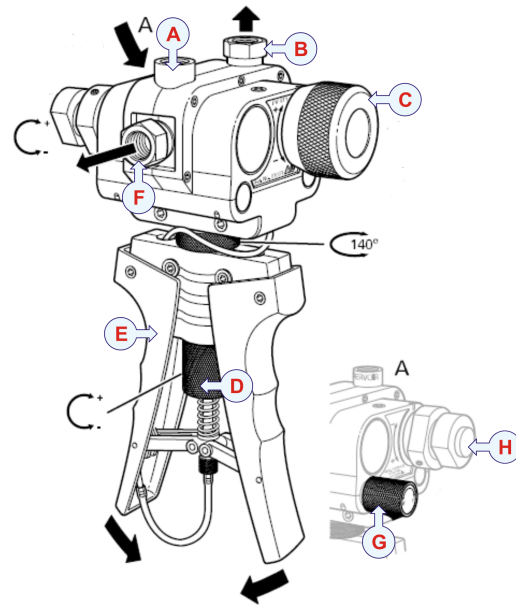

Assemble the test kit

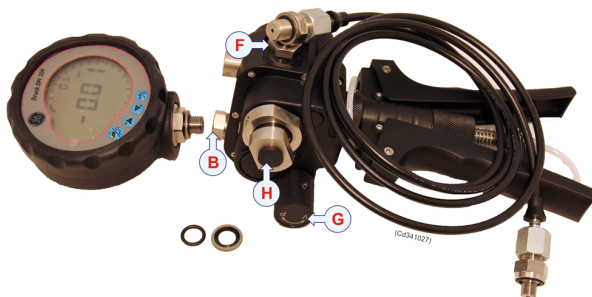

Purpose

This procedure explains how to assemble the hand pump, the digital pressure indicator and the relevant tube and fittings to test that a unit is properly sealed and watertight.

Procedure

- 1 Make sure there is an O-ring in the outlet port **B**.
- 2 Connect the Digital pressure indicator to outlet port **B** and use a spanner to tighten.

- 3 Make sure there is a small O-ring in the flexible pipe and connect the adapter fitting to the test port for the seal being tested.
- 4 Make sure there is an O-ring in the other end of the flexible pipe and connect a ¼ BSP.
- 5 Place a washer on the ¼ BSP and connect to the outlet port F on the test kit.

Testing the seal

Purpose

This procedure explains how you can use the interseal test kit to verify that the unit to be tested is properly sealed and watertight.

Related topics

- *Druck DPI104 Digital pressure indicator user manual*
- *Druck PV411A Hand-pump user manual*
- *Assemble the test kit on page 87*

Important

Before you apply pressure, make sure that all connections are correct, and that all equipment are clean and free from damage.

Do not exceed the maximum test pressure of 11 bar.

Never use tools to fasten the fittings, hand power is enough.

Procedure

- 1 Assemble the test kit.
→ *Assemble the test kit on page 87*
- 2 Make sure the unit to be tested, and the connections are clean. Verify that the O-rings on the fittings are lubricated properly.

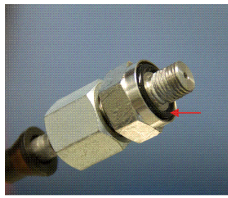

- 3 Connect the flexible pipe between the interseal test kit and the unit to be tested.
- 4 Start the Digital pressure indicator by pressing the power on button, A.



- 5 If the pressure unit is not Bar, see the Digital pressure indicator manual to change it.
- 6 Close the selector valve, **G** by turning clockwise.
- 7 Use the scissor-action handles to pump up the pressure to 11 bar.



(Cd341012c)

- 8 Adjust with the volume adjuster, **C** if necessary.
- 9 Let the system rest for 10 minutes, and write down the pressure.
- 10 Let the system rest for another 10 minutes, and check the pressure again.
- 11 Make sure that the pressure has dropped less than 100 mbar.
This verifies that the seal is undamaged.
- 12 Open the selector valve, **G** carefully to remove the pressure by turning counterclockwise.

Changing the battery in the Digital pressure indicator

Purpose

This procedure explains how to change the battery on the Digital pressure indicator.

Procedure

Important

Take extra care while changing the battery not to damage any of the cords inside the Digital pressure indicator.

- 1 Remove the rubber cover.
- 2 Use a screwdriver in the slit on the side of the unit to lift the top cover **straight** up. Do not twist or the cords from the unit to the display will get damaged.
- 3 Unscrew the battery clamp, and disconnect the battery connector.

- 4 Connect a new 9-volt battery and assemble everything in the reverse order.

Illustrated spare parts catalogue

This chapter provides you with an illustrated listing of the spare parts that may be replaced on the ACS500.

Important

The line replaceable units are defined. Additional spares are also identified.

Topics

- *Line replaceable units* on page 92
- *Ordering spare parts* on page 93
- *Acoustic Command Unit spare parts* on page 93
- *Dunking transducer spare parts* on page 94
- *Subsea Control Unit spare parts* on page 95
- *Subsea transducer spare parts* on page 98
- *Test equipment spare parts* on page 99
- *O-ring kits* on page 101

Line replaceable units

Acoustic Command Unit

The following parts have been defined as line replaceable units in the ACU.

- Acoustic Command Unit – Complete unit (The unit must be configured by Kongsberg Maritime service personnel)
- Battery

Dunking transducer

The following parts have been defined as line replaceable units for dunking transducers:

- Dunking transducer– Complete unit

Subsea Control Unit

The following parts have been defined as line replaceable units for the SCU:

- Subsea Control Unit – Complete unit
- Battery
- Top end cap – Complete top end cap with O-rings
- Vent screw – Complete with O-ring
- Top end cap maintenance kit – All O-rings and test port screw
- Bracket
- Junction box
- All cables
- External quad battery unit

Subsea transducer

The following parts have been defined as line replaceable units for subsea transducers:

- Subsea transducer– Complete unit
- Subsea transducer – Transducer cable

Test equipment

The following parts have been defined as line replaceable units for the test equipment.

- Simulator
- Simulator test cable
- Patch cable for testing with HiPAP
- Transducer test cable
- Interseal test kit

Ordering spare parts

In order to make the ordering of spare parts as effective and safe as possible, please provide the best possible information about the following details:

- Part name and/or description
- Our part number
- Number of units required
- Your shipment address
- Preferred shipment method
- Required date of delivery from us

For certain spare parts (typically complete units, printed circuit boards and software) the vessel name is also useful, as this allows us to update our vessel database.

Acoustic Command Unit spare parts

All spare parts for the ACU are listed here.

- *Acoustic Command Unit line replaceable units* on page 93
- *Acoustic Command Unit, complete unit* on page 94
- *Acoustic Command Unit, battery* on page 94

Acoustic Command Unit line replaceable units

The following parts have been defined as line replaceable units in the ACU.

- Acoustic Command Unit – Complete unit (The unit must be configured by Kongsberg Maritime service personnel)
- Battery

Acoustic Command Unit, complete unit

Item information

- **Part name:** ACU 30
- **Part number:** 320101



Acoustic Command Unit, battery

Item information

- **Part name:** ACU 30 battery
- **Part number:** 373780



Dunking transducer spare parts

All spare parts for the dunking transducer are listed here.

- *Dunking transducer line replaceable units* on page 94
- *Dunking transducer, complete unit* on page 94

Dunking transducer line replaceable units

The following parts have been defined as line replaceable units for dunking transducers:

- Dunking transducer– Complete unit

Dunking transducer, complete unit

Item information

- **Part name:** Dunking transducer TDD30V
- **Part number:** 320680



Item information

- **Part name:** Dunking transducer TDD303
- **Part number:** 301518



Item information

- **Part name:** Dunking transducer TDD180
- **Part number:** 320822



Subsea Control Unit spare parts

All spare parts for the SCU are listed here.

- *Subsea Control Unit line replaceable units on page 95*
- *Subsea Control Unit, complete unit on page 96*
- *Subsea Control Unit, battery on page 96*
- *Subsea Control Unit, top end cap on page 96*
- *Subsea Control Unit, vent screw for top end cap on page 96*
- *Subsea Control Unit, maintenance kit for top end cap on page 97*
- *Subsea Control Unit, bracket on page 97*
- *Subsea Control Unit, junction box on page 97*
- *Subsea Control Unit, interface jumper cable on page 97*
- *Subsea Control Unit, interface cable on page 98*
- *Subsea Control Unit, serial line cable on page 98*
- *Subsea Control Unit, sealing cap for 12-pins connector on page 98*
- *Subsea Control Unit, external quad battery unit on page 98*

Subsea Control Unit line replaceable units

The following parts have been defined as line replaceable units for the SCU:

- Subsea Control Unit – Complete unit
- Battery
- Top end cap – Complete top end cap with O-rings
- Vent screw – Complete with O-ring
- Top end cap maintenance kit – All O-rings and test port screw
- Bracket
- Junction box
- All cables
- External quad battery unit

Subsea Control Unit, complete unit

Item information

- **Part name:** SCU 34 MF
- **Part number:** See the registration form for part number information
- **Part name:** SCU 34 48V
- **Part number:** See the registration form for part number information



Subsea Control Unit, battery

Item information

- **Part name:** Lithium battery pack
- **Part number:** 319554



Subsea Control Unit, top end cap

Item information

The top end cap is delivered with all O-rings.

- **Part name:** SCU34 Top end cap
- **Part number:** 317930



Subsea Control Unit, vent screw for top end cap

Item information

The vent screw is delivered with both O-rings.

- **Part name:** Vent screw
- **Part number:** 341596



Subsea Control Unit, maintenance kit for top end cap

Item information

The maintenance kit consists of:

- Seal screw
- Lock cord
- EMI shield
- 1 x O-ring 112 mm
- 3 x O-ring 107 mm
- 2 x O-ring 12 mm
- 2 x O-ring 11 mm
- 2 x O-ring 10 mm
- **Part name:** SCU Maintenance kit for top end cap
- **Part number:** 341594

Subsea Control Unit, bracket

Item information

- **Part name:** Bracket for ACS
- **Part number:** 328316

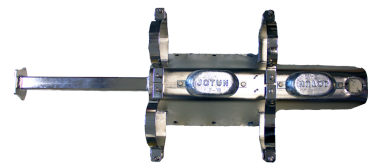

Subsea Control Unit, junction box

Item information

- **Part name:** SCU junction box
- **Part number:** 319943

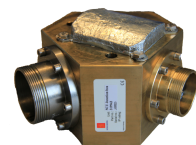

Subsea Control Unit, interface jumper cable

Item information

- **Part name:** Interface jumper cable
- **Part number:** 331643



Subsea Control Unit, interface cable

Item information

- **Part name:** Interface cable
- **Part number:** This cable is customer specific. See the registration form for part number information.



Subsea Control Unit, serial line cable

Item information

- **Part name:** Serial line cable, SL A6 5 G7
- **Part number:** 416396

Subsea Control Unit, sealing cap for 12-pins connector

Item information

- **Part name:** Sealing cap MacArtney
- **Part number:** 332269



Subsea Control Unit, external quad battery unit

Item information

- **Part name:** External quad battery for SCU
- **Part number:** 347007



Subsea transducer spare parts

All spare parts for the subsea transducer are listed here.

Subsea transducer line replaceable units

The following parts have been defined as line replaceable units for subsea transducers:

- Subsea transducer– Complete unit
- Subsea transducer – Transducer cable

Subsea transducer, complete unit

Item information

- **Part name:** Subsea transducer TDR30V
- **Part number:** 3320098



Item information

- **Part name:** Subsea transducer TDR40V 34S
- **Part number:** 364096



Item information

- **Part name:** Subsea transducer TDR180
- **Part number:** 320890



Test equipment spare parts

All spare parts for the test equipment are listed here.

- *Test equipment line replaceable units* on page 100
- *Simulator* on page 100
- *Simulator test cable* on page 100
- *Patch cable for testing with HiPAP* on page 100
- *Transducer test cable* on page 100
- *Interseal test kit* on page 101

Test equipment line replaceable units

The following parts have been defined as line replaceable units for the test equipment.

- Simulator
- Simulator test cable
- Patch cable for testing with HiPAP
- Transducer test cable
- Interseal test kit

Simulator

Item information

- **Part name:** SIM 30-41 SC (ACS Field Simulator, 16 channels)
- **Part number:** 388008



Simulator test cable

Item information

- **Part name:** Simulator test cable
- **Part number:** Customer specific, see the registration form.

Patch cable for testing with HiPAP

Item information

- **Part name:** Patch cable
- **Part number:** 382483

Transducer test cable

Item information

- **Part name:** Transducer test cable
- **Part number:** 380-103277

Interseal test kit

Item information

- **Part name:** Interseal test kit
- **Part number:** 359195



O-ring kits

All O-ring kits are listed here.

- on page
- on page
- *O-ring for external quad battery* on page 101

O-ring for external quad battery

Item information

- **Part name:** O-ring for external quad battery
- **Part number:** 540-086946

Equipment handling

This section provides the basic rules for transportation, storage and handling of units. In this context, a unit may be any large or small part of the system. It can be supplied as part of the initial delivery, or as a spare part.

Topics

- *Disposal* on page 103
- *Inspection* on page 103
- *Lifting* on page 103
- *Re-packaging* on page 104
- *Storage after unpacking* on page 104
- *Storage after use* on page 105
- *Unpacking* on page 107
- *Transportation* on page 109

Disposal

At the end of the product lifetime, all Kongsberg Maritime products must be disposed in an environmental friendly way.

Kongsberg Maritime offers a product recycling service and we recommend that this is used. The service is described on <http://www.km.kongsberg.com> →Products →Services →Product recycling.

All electrical and electronic components must be disposed of separately from the municipal waste stream via designated collection facilities appointed by the government or local authorities. The correct disposal and separate collection of your old appliance will help prevent potential negative consequences for the environment and human health. This is a precondition for reuse and recycling of used electrical and electronic equipment. For more detailed information about disposal of your old appliance, please contact your local authorities or waste disposal service.

All disposal of mechanical, electromechanical, electronic and chemical waste – including all types of batteries – must thus be disposed of according to national and international rules and regulations. Observe the relevant Waste Electrical and Electronic Equipment (WEEE) regulations.

Inspection

An inspection must be carried out immediately after the unit(s) have arrived at their destination.

- 1 Check all wooden or cardboard boxes, plastic bags and pallets for physical damage. Look for signs of dropping, immersion in water or other mishandling.
- 2 If damage is detected externally, you will have to open the packaging to check the contents. Request a representative of the carrier to be present while the carton is opened, so any transportation damage can be identified.
- 3 If any units are damaged, prepare an inspection report stating the condition of the unit and actions taken. Describe the damage and collect photographic evidence if possible. Send the inspection report to Kongsberg Maritime as soon as possible.
- 4 If the units are not damaged, check the humidity absorbing material. If required, dry or replace the bags, then re-pack the unit(s) according to the packing instructions.

Lifting

A heavy crate will normally be marked with its weight, and the weights of other cartons or crates will normally be entered on the packing list.

- You must always check the weight of a crate before you attempt to lift it.
- You must always use lifting apparatus that is approved and certified for the load.

Heavy units may be equipped with lifting lugs for transportation by crane within the workshop or installation area. Before you use a crane:

- You must check the applicable weight certificate for the crane.
- You must check the security of the lifting lugs.

Ensure that all available lifting lugs are used. Ensure the unit remains under control during the operation to avoid damage to the unit, equipment or personnel.

Heavy units may be transported using a forklift truck. Special attention must then be paid to the position of the unit's centre of gravity. The units must be properly secured to the truck.

Re-packaging

Whenever possible, the unit must be stored and transported in its original packing material and/or crate. In the event that this material is not available, proceed as follows:

- Small units must be protected from damp by being placed within a plastic bag at least 0.15 mm thick. An appropriate quantity of desiccant material should be placed inside this bag, and the bag sealed. The sealed unit must then be placed in an appropriate carton or crate, and supported in the container by appropriate shock-absorbing insulation (polystyrene foam chips etc.).
- Large units must be placed in a suitable cardboard box or wooden crate. The unit must be protected against physical damage by means of shock-absorbing insulation mats. The box must be clearly marked with its contents, and must be stored in a dry and dust-free area.

Storage after unpacking

The unit must whenever possible be stored in its original transportation crate until ready for installation. The crate must not be used for any purpose for which it was not intended (eg. work platform etc.).

Once unpacked, the equipment must be kept in a dry, non condensing atmosphere, free from corrosive agents and isolated from sources of vibration.

Note

Do not break the seal to open a circuit board package before the board is to be used. If the board package is returned to the manufacturers with the seal broken, the contents will be assumed to have been used and the customer will be billed accordingly.

The unit must be installed in its intended operating position as soon as possible after unpacking. If the unit contains normal batteries, these may have been disconnected/isolated before the unit was packed. These must then be reconnected during the installation procedure. Units containing batteries are marked.

Note

Units containing lithium or alkaline batteries must be handled separately and with care. Such units are marked accordingly. Do not attempt to recharge such batteries, open them or dispose of them by incineration. Refer to the applicable product data sheets.

Storage after use

If a unit is removed from its operating location and placed into storage, it must be properly cleaned and prepared before packing.

Cleaning cabinets

If a cabinet has been exposed to salt atmosphere while it was in use, it must be thoroughly cleaned both internally and externally to prevent corrosion.

- 1 Wipe the cabinet externally using a damp cloth and a little detergent. Do not use excessive amounts of water as the unit may not be water tight. On completion, dry the unit thoroughly.
- 2 All surfaces must be inspected for signs of corrosion, flaking/bubbling paint, stains etc. Damaged or suspect areas must be cleaned, prepared and preserved using the correct preservation mediums for the unit. The mediums to be used will usually be defined in the units' maintenance manual.
- 3 Open the unit, and using a vacuum cleaner, remove all dust etc. from the unit. Great care must be taken to ensure the circuit boards and modules are not damaged in the process.

Mechanical units

If a mechanical unit have been exposed to a salt atmosphere or corrosive environment while it was in use, it must be thoroughly cleaned both internally and externally to prevent corrosion.

- 1 If the construction materials and type of unit permits, wash the unit using a high-pressure hose and copious amounts of fresh water. Examples are the lower parts of hull units (outside the hull) or subsea units
- 2 Ensure that all traces of mud and marine growth are removed. Use a wooden or plastic scraper to remove persistent growth, barnacles etc. On completion, dry the unit thoroughly.

Caution

Do not use a high pressure hose in the vicinity of cables or transducers. Do not use sharp or metal tools on a transducer face.

- 3 If the materials or type of unit prevents the use of a high-pressure hose, wipe the unit using a cloth dampened with water containing a little detergent. Examples are the upper parts of hull units (inside the hull) and hydraulic systems
- 4 Do not use excessive amounts of water as some components on the unit may not be water tight. Wipe off the detergent with a damp cloth, then dry the unit thoroughly.
- 5 All surfaces must be inspected for signs of corrosion, flaking/bubbling paint, stains etc. Damaged or suspect areas must be cleaned, prepared and preserved using the correct preservation mediums. The mediums to be used will normally be defined in the unit's maintenance manual.

Cables

Wipe clean all exposed cables, and check for damage. If a cable shows signs of wear or ageing, contact Kongsberg Maritime for advice.

Dehumidifier

Place a suitably sized bag of desiccant material (silica gel or similar) into the unit to keep the electronic components as dry as possible.

Coatings

Spray the unit externally with a corrosion inhibitor (e.g. a light oil) before packing.

Storage prior to installation or use

When a system, a unit or a spare part has been delivered to the customer, it may be subject to long time storage prior to installation and use. During this storage period, certain specifications must be met. The equipment must be preserved and stored in such a way that it does not constitute any danger to health, environment or personal injury.

- 1 The equipment must be stored in its original transportation crate.
- 2 Ensure that the units are clearly separated in the shelves and that each unit is easily identifiable.
- 3 The crate must not be used for any purpose for which it was not intended (eg. work platform etc.).
- 4 The crates must not be placed on top of each other, unless specific markings permit this.
- 5 The crates must not be placed directly on a dirt-floor.
- 6 Do not open the crate for inspection unless special circumstances permit so.
 - “Special circumstances” may be suspected damage to the crate and its content, or inspections by civil authorities.

- If any units are damaged, prepare an inspection report stating the condition of the unit and actions taken. Describe the damage and collect photographic evidence if possible. Re-preserve the equipment.
 - If the units are not damaged, check the humidity absorbing material. If required, dry or replace the bags, then re-pack the unit(s) according to the packing instructions.
- 7 If the crate has been opened, make sure that it is closed and sealed after the inspection. Use the original packing material as far as possible.
 - 8 The storage room/area must be dry, with a non-condensing atmosphere. It must be free from corrosive agents.
 - 9 The storage area's mean temperature must not be lower than -30°C , and not warmer than $+70^{\circ}\text{C}$. If other limitations apply, the crates will be marked accordingly.
 - 10 The crate must not be exposed to moisture from fluid leakages.
 - 11 The crate must not be exposed to direct sunlight or excessive warmth from heaters.
 - 12 The crate must not be subjected to excessive shock and vibration.
 - 13 If the unit contains normal batteries, these may have been disconnected/isolated before the unit was packed. These must only be reconnected before the installation starts. Units containing batteries are marked.

Caution

Units containing lithium or alkaline batteries must be handled separately and with care. Such units are marked accordingly. Do not attempt to recharge such batteries, open them or dispose of them by incineration. Refer to the applicable product data sheets.

Unpacking

General unpacking procedure

Normal precautions for the handling, transportation and storage of fragile electronic equipment must be undertaken.

Note

If the unit is not to be prepared for immediate use, you may consider storing it unopened in its original packing material. However, it may be useful to open the case to check its contents for damage and retrieve any accompanying documentation.

Do not use a knife to open cardboard cartons - the contents may lie close to the surface, and may be damaged by the blade.

- 1 Check the carton before opening it to ensure it shows no signs of dropping, immersion in water or other mishandling. If the carton shows signs of such damage, refer to the paragraph covering Inspection on receipt.

- 2 Place the carton on a stable work bench or on the floor with the top of the carton uppermost.
- 3 In the absence of other instructions, always open the top of the carton first. The contents will normally have been lowered into the carton from above, so this will usually be the easiest route to follow. Care must be used when opening the carton to ensure the contents are not damaged. Do not use a knife to open cardboard cartons
- 4 If the carton has been closed using staples, remove the staples from the carton as you open it. This will reduce the possibilities of scratch injury to yourself and damage to the contents.
- 5 If a wooden crate has been closed using screws, always remove them using a screwdriver. Do not attempt to prise the lid off with a crowbar or similar.
- 6 Once the carton is open, carefully remove all loose packing and insulation material. Check for manuals and other documents that may have been added to the carton during packing, and put these to one side. Check also for special tools, door keys etc.

Unpacking electronic and electromechanical units

Electronic and electromechanical units will normally be wrapped in a clear plastic bag. Lift the unit, in its bag, out of the carton and place it in a stable position on the floor/work bench.

Inspect the unit for damage before opening the plastic bag.

Note

Beware of the dangers of Electro-Static Discharge (ESD) both to yourself and to the equipment, when handling electronic units and components.

*Cables must **never** be used as carrying handles or lifting points.*

Do not break the seal to open a circuit board package before the board is to be used. If the board package is returned to the manufacturer with the seal broken, the contents will be assumed to have been used and the customer will be billed accordingly.

Assuming all is well, open the bag and remove the unit.

Open the unit and check inside. Remove any packing and desiccant material that may be inside.

Unpacking mechanical units

Mechanical units may be heavy. Using a suitably certified lifting apparatus, lift the unit out of the crate and place it in a stable position on the floor/work bench.

Inspect the unit for damage and remove any packing material that may be inside the unit.

Transportation

Unless otherwise stated in the accompanying documentation, electronic, electro-mechanical and mechanical units supplied by Kongsberg Maritime can be transported using all methods approved for delicate equipment; (by road, rail, air or sea). The units are to be transported in accordance with general or specific instructions for the appropriate unit(s), using pallets, transport cases, or carton boxes as appropriate.

Note

Special local restrictions concerning air transportation may be applied to units containing certain types of batteries. These units must be checked properly, and the regulations must be investigated by the packer/shipper before the unit is dispatched.

All local transportation must be carried out according to the same specifications as for the initial delivery. In general, all units must be handled with care.

The carton or case containing the unit must be kept dry at all times, and must be sheltered from the weather. It must not be subjected to shocks, excessive vibration or other rough handling. The carton or case will normally be marked with text or symbols indicating which way it is to be placed. Follow any instructions given, and ensure the case is always placed with its “top” uppermost.

The carton or case must not be used for any purpose for which it was not intended (step, table, etc.), and in the absence of other information, no other cartons or cases must be stacked on top of it.

Drawing file

This chapter contains relevant drawings related to the installation and maintenance of the Kongsberg ACS500.

Note

These mechanical drawings are for information and guidance only. They are not in scale. All dimensions are in mm unless otherwise is noted. The original installation drawings are available on PDF and/or AutoCad's DWG format.

Topics

- *Dunking transducer unit, outline dimensions on page 111*
- *Acoustic Command Unit, outline dimensions on page 112*
- *Subsea Control Unit, outline dimensions on page 113*
- *Subsea Control Unit, arrangement on page 114*
- *Subsea Control Unit, bracket on page 115*
- *TDR30V Subsea transducer, outline dimensions on page 116*
- *TDR40V 34S Subsea transducer, outline dimensions on page 117*
- *TDR180 Subsea transducer, outline dimensions on page 118*
- *External quad battery unit for SCU, outline dimensions on page 119*

Dunking transducer unit, outline dimensions

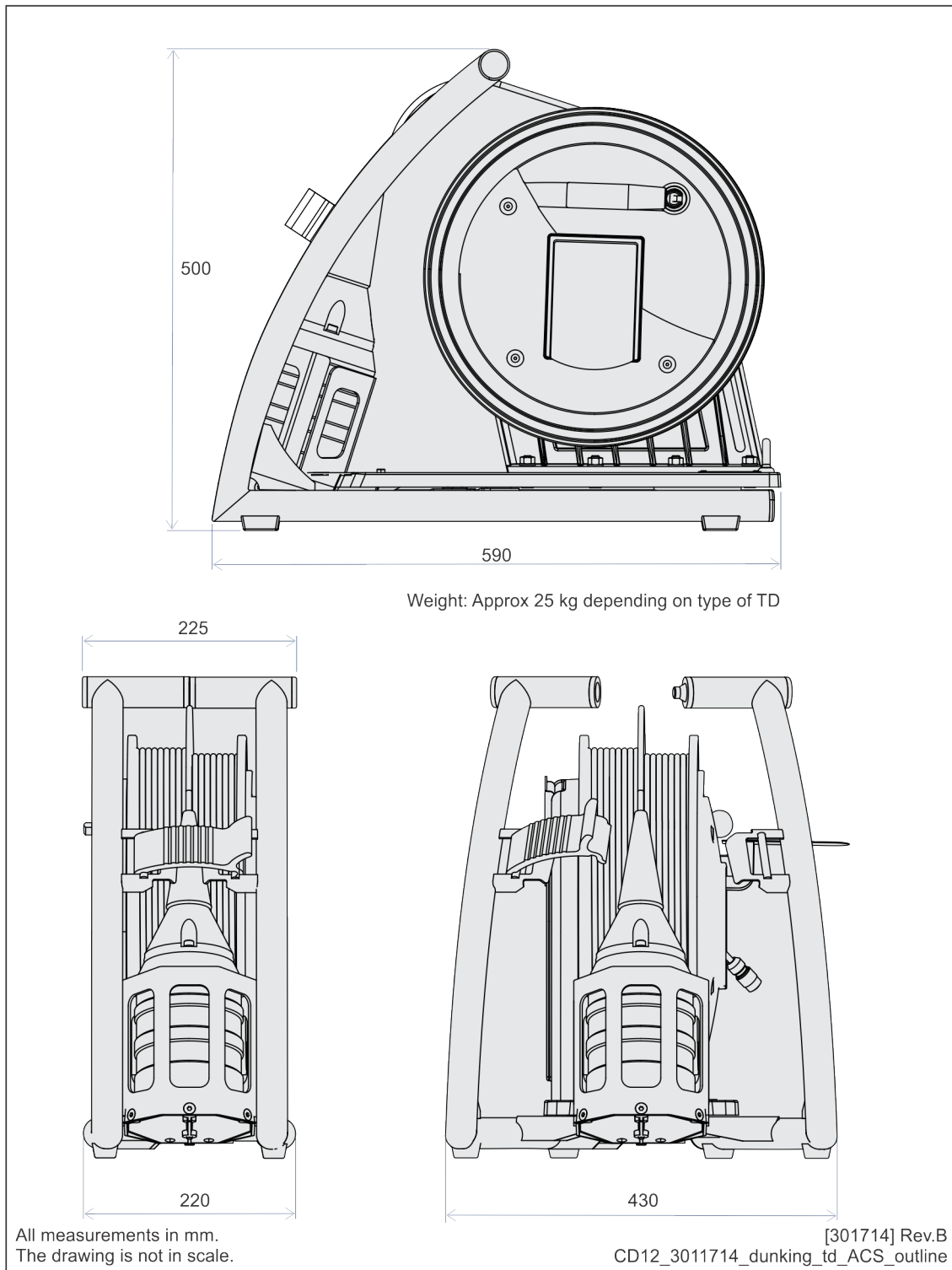

Acoustic Command Unit, outline dimensions

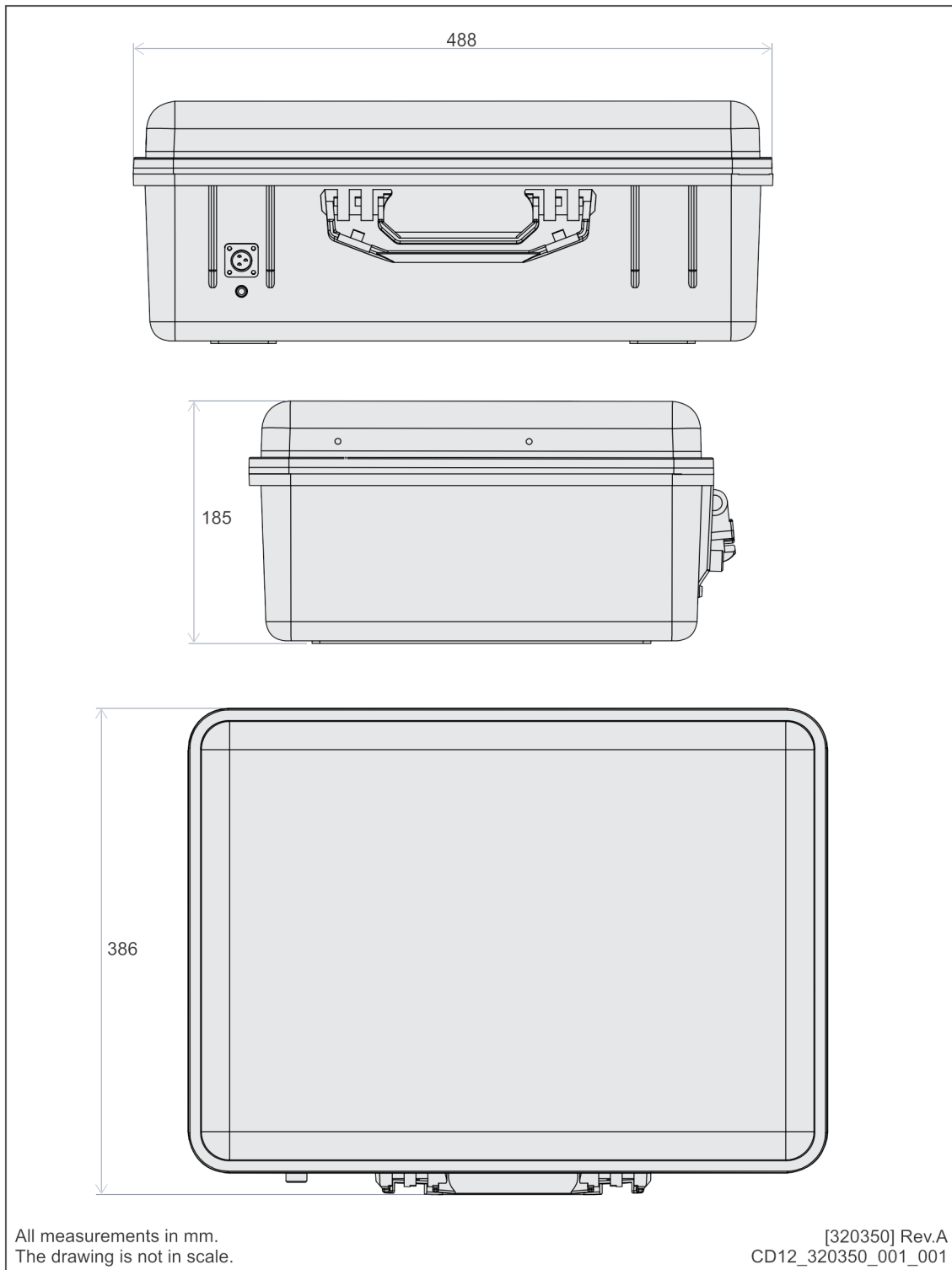

Subsea Control Unit, outline dimensions

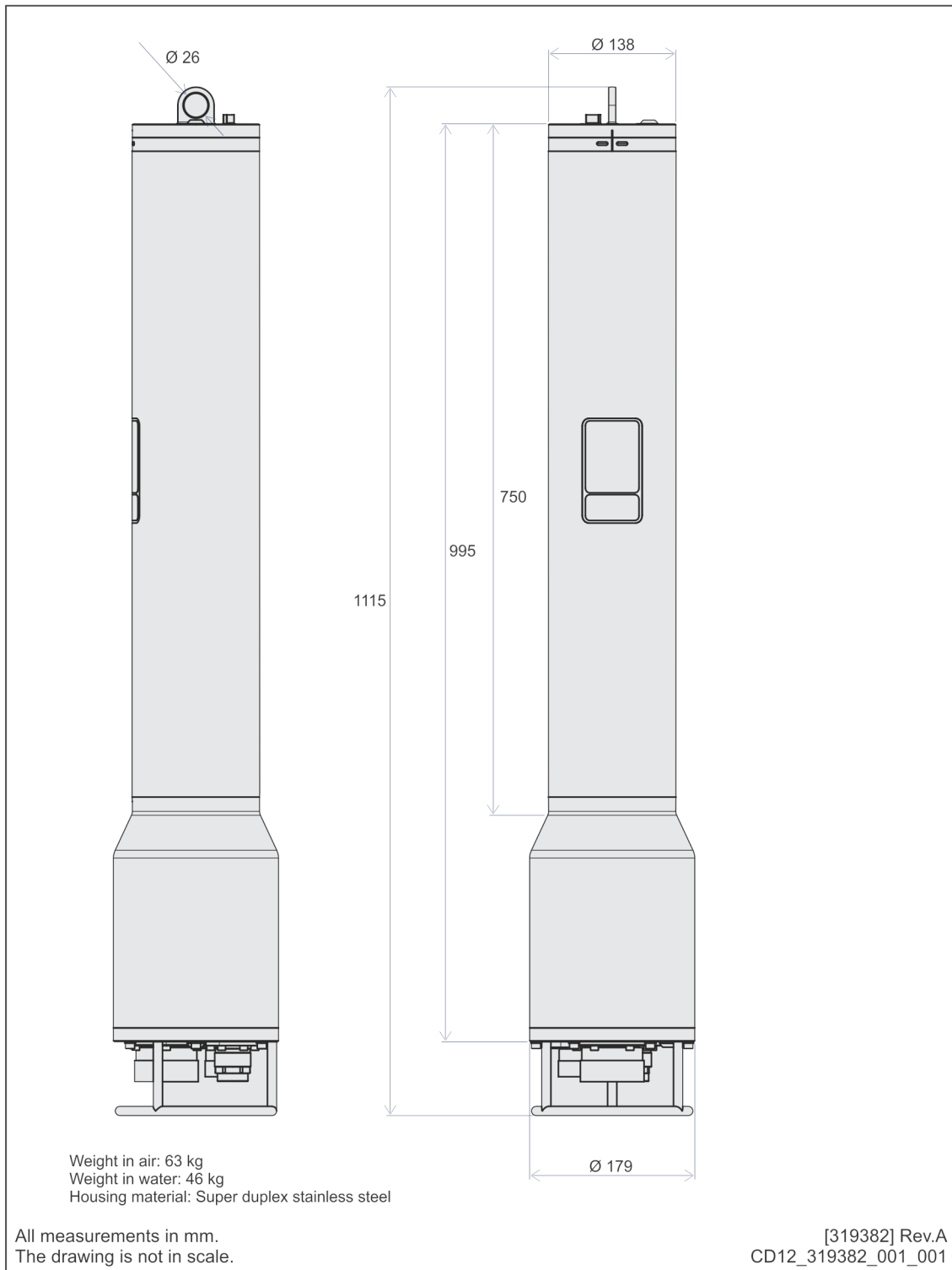

Subsea Control Unit, arrangement

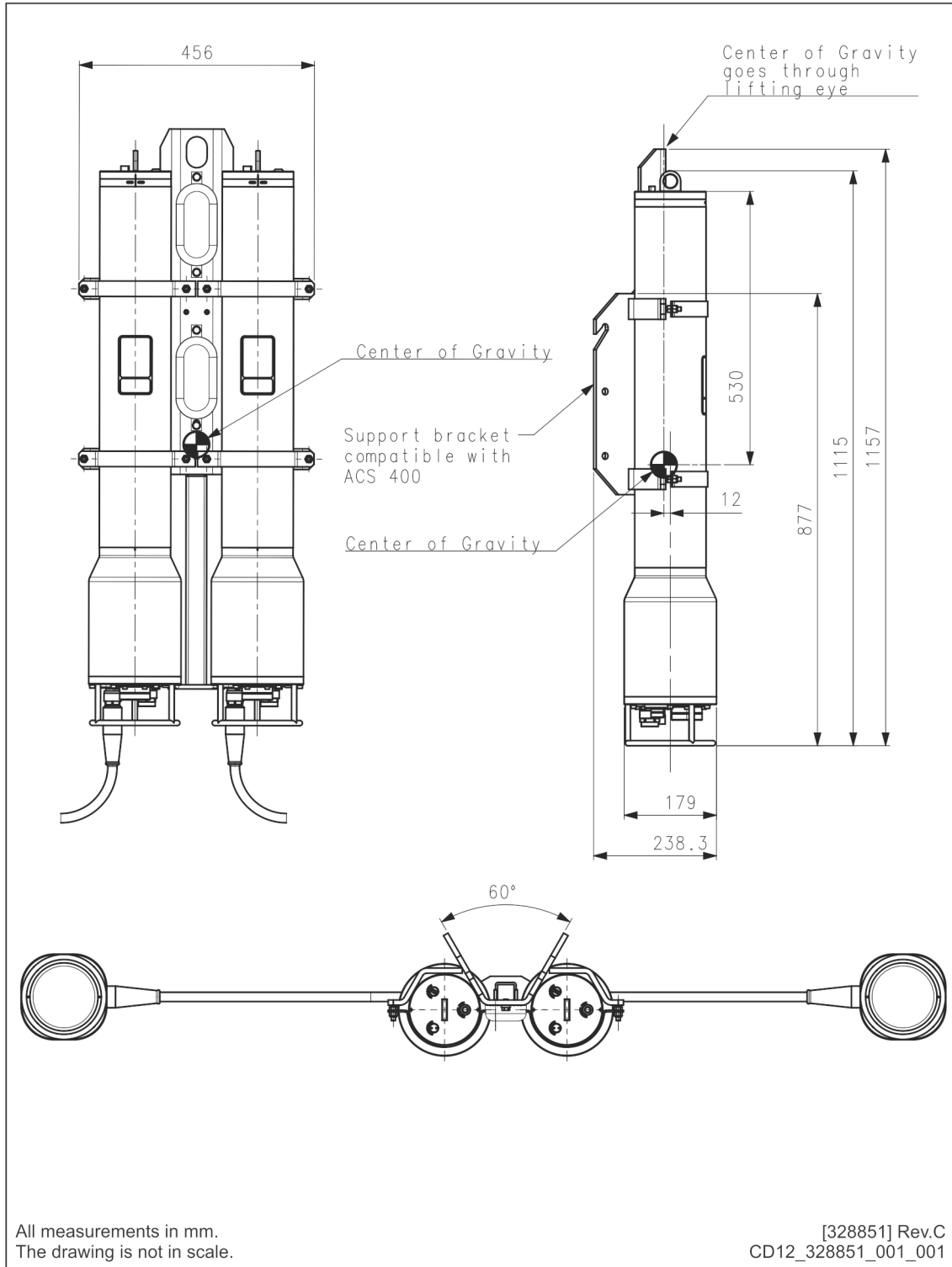

Subsea Control Unit, bracket

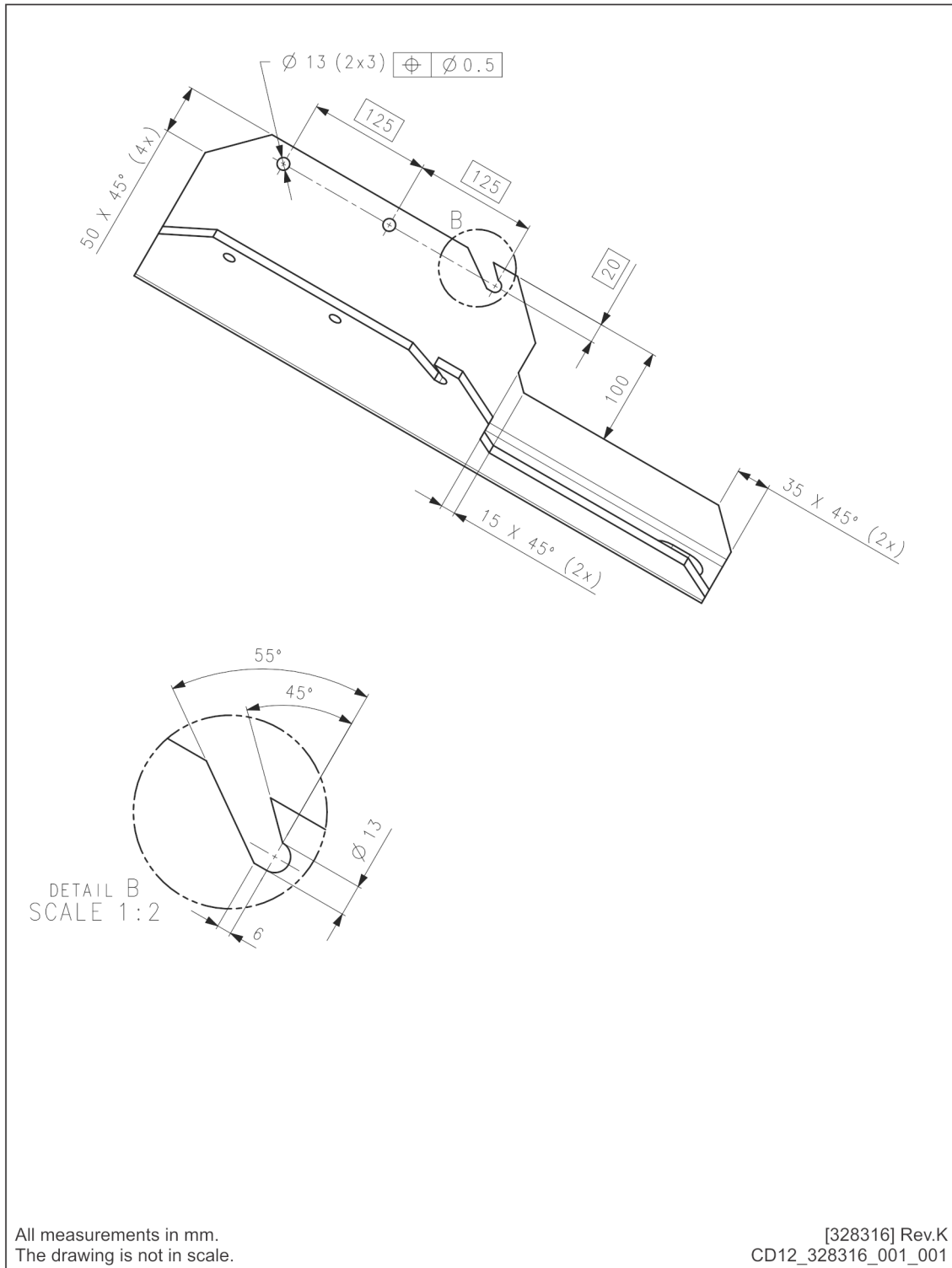

TDR30V Subsea transducer, outline dimensions

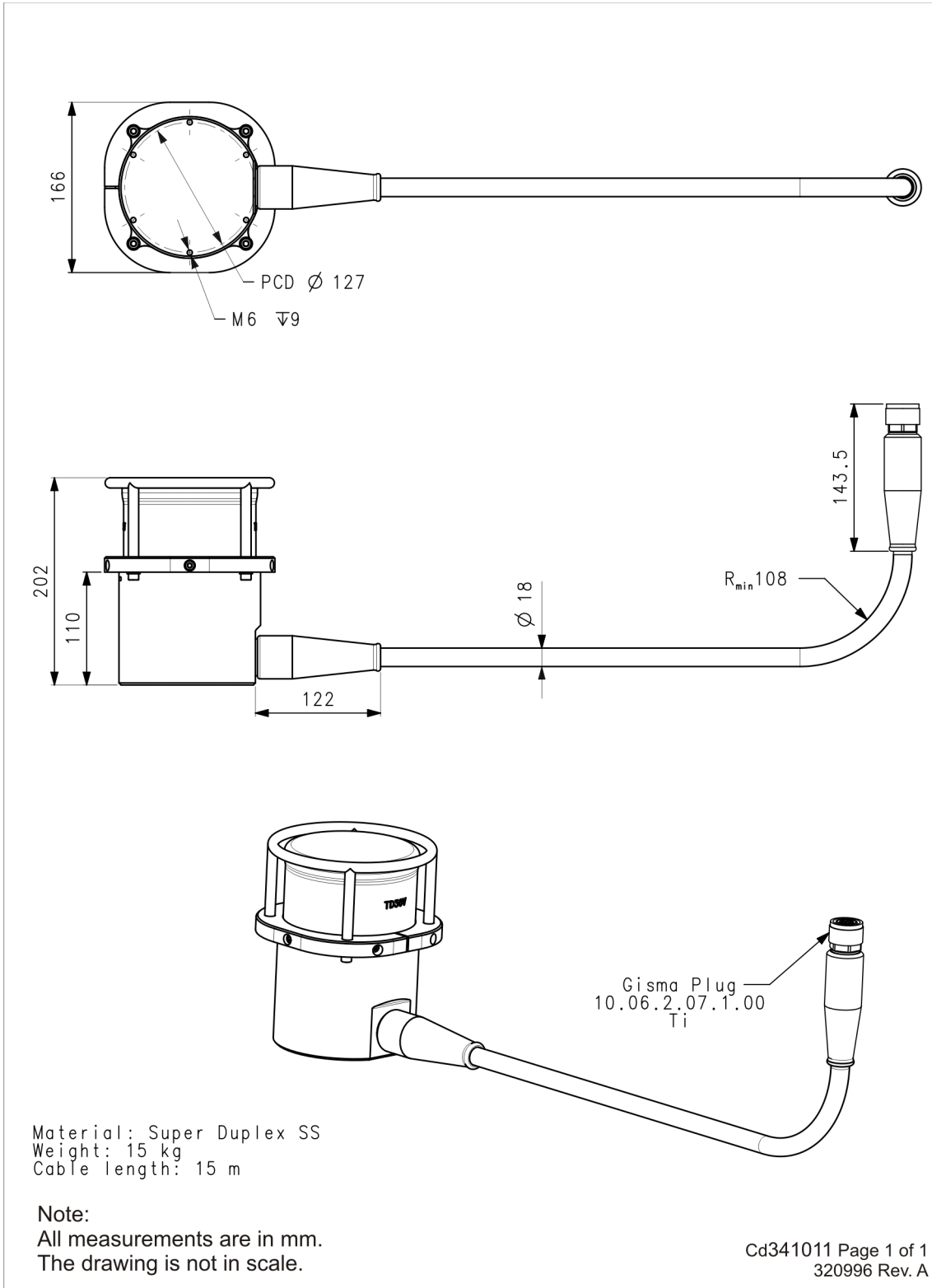

TDR40V 34S Subsea transducer, outline dimensions

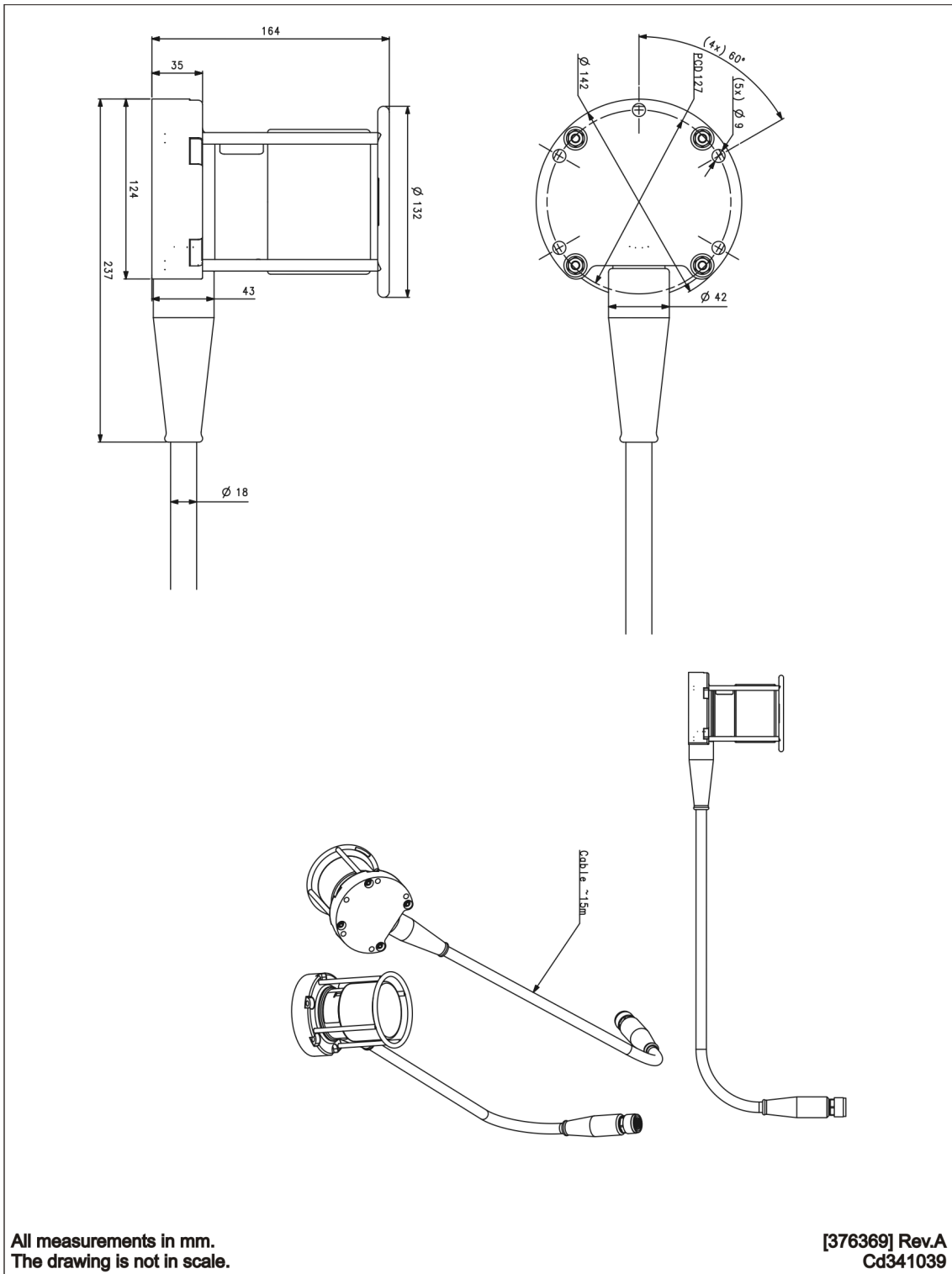

TDR180 Subsea transducer, outline dimensions

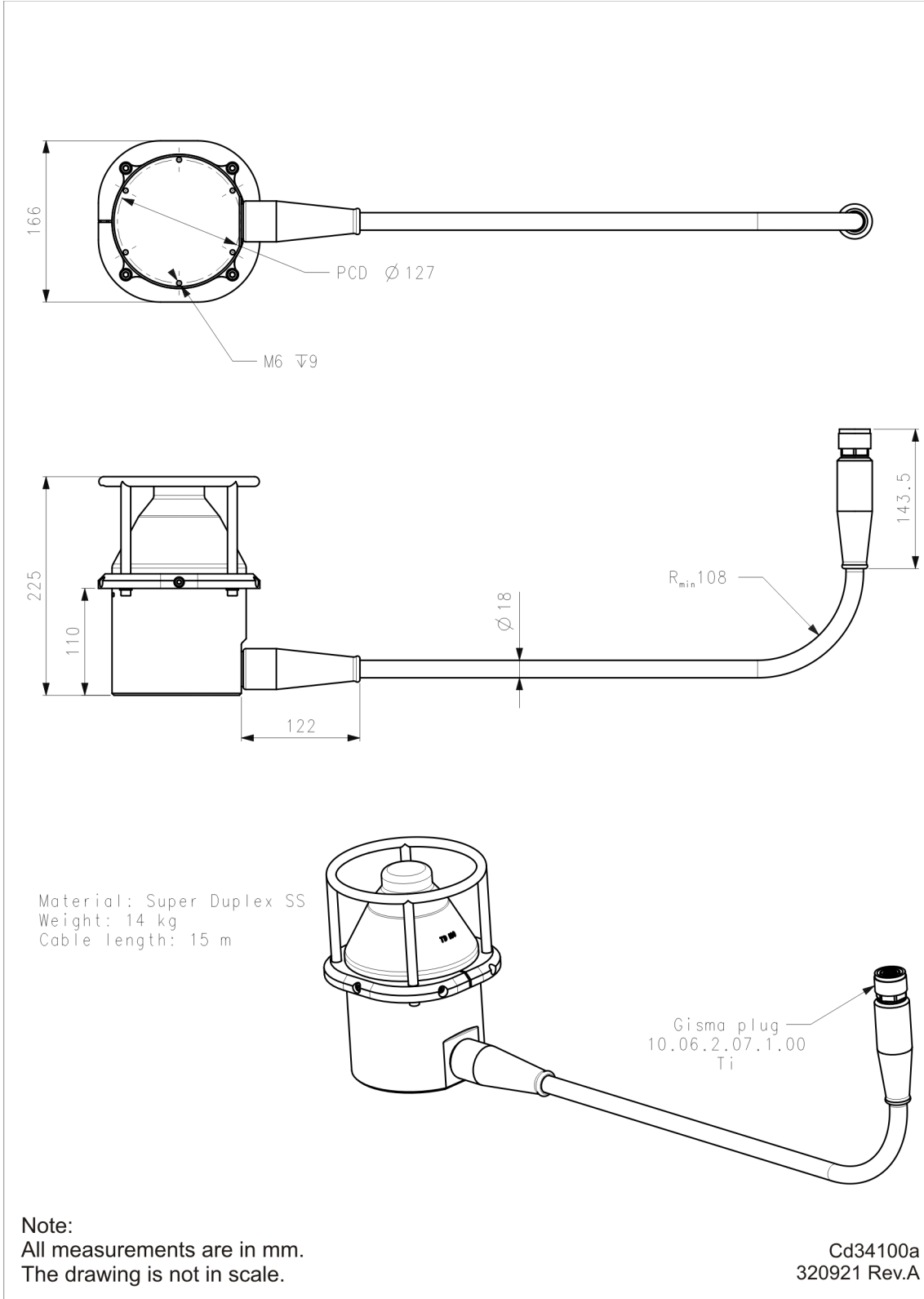

External quad battery unit for SCU, outline dimensions

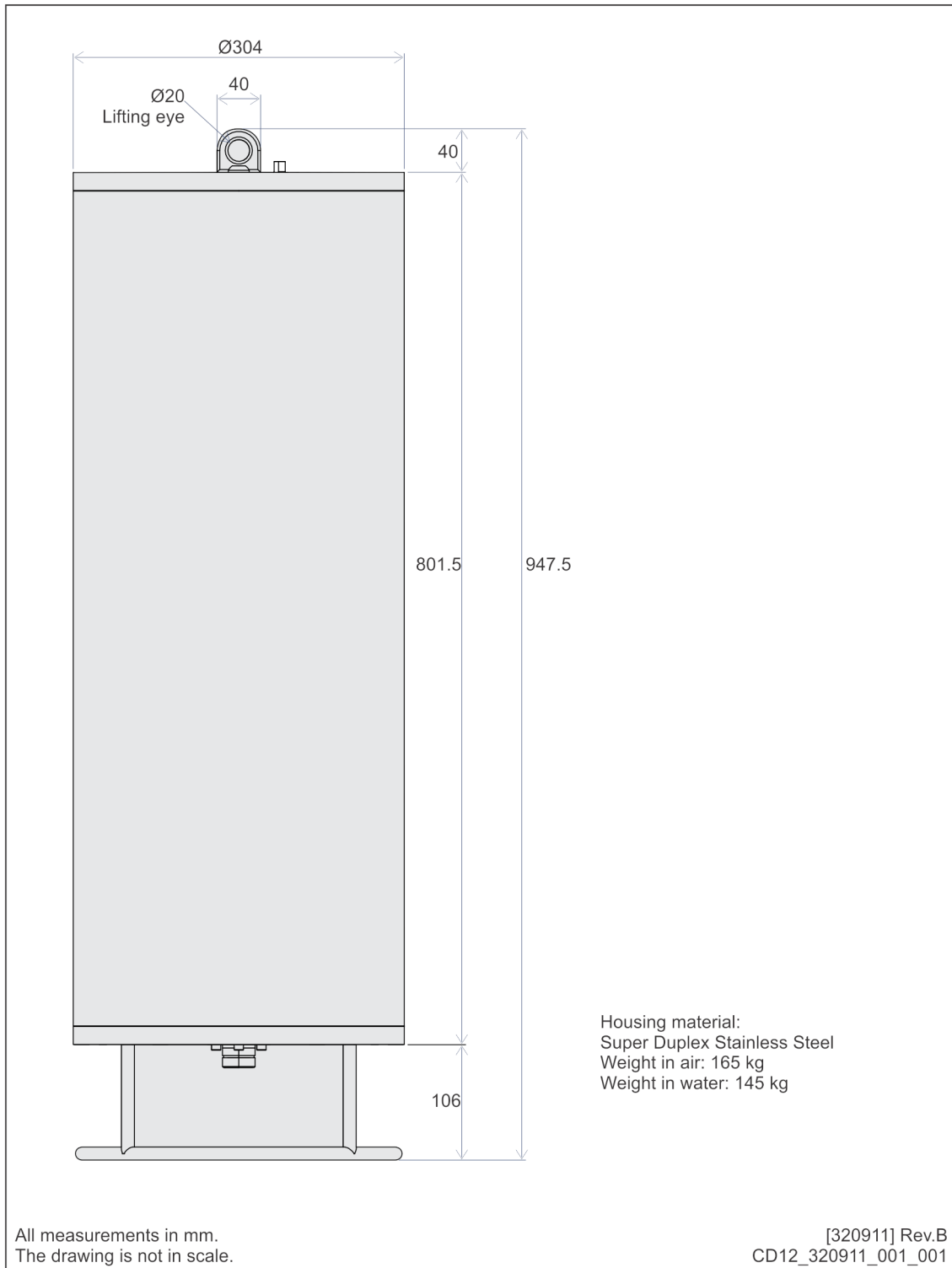

16 channel field simulator, outline dimensions

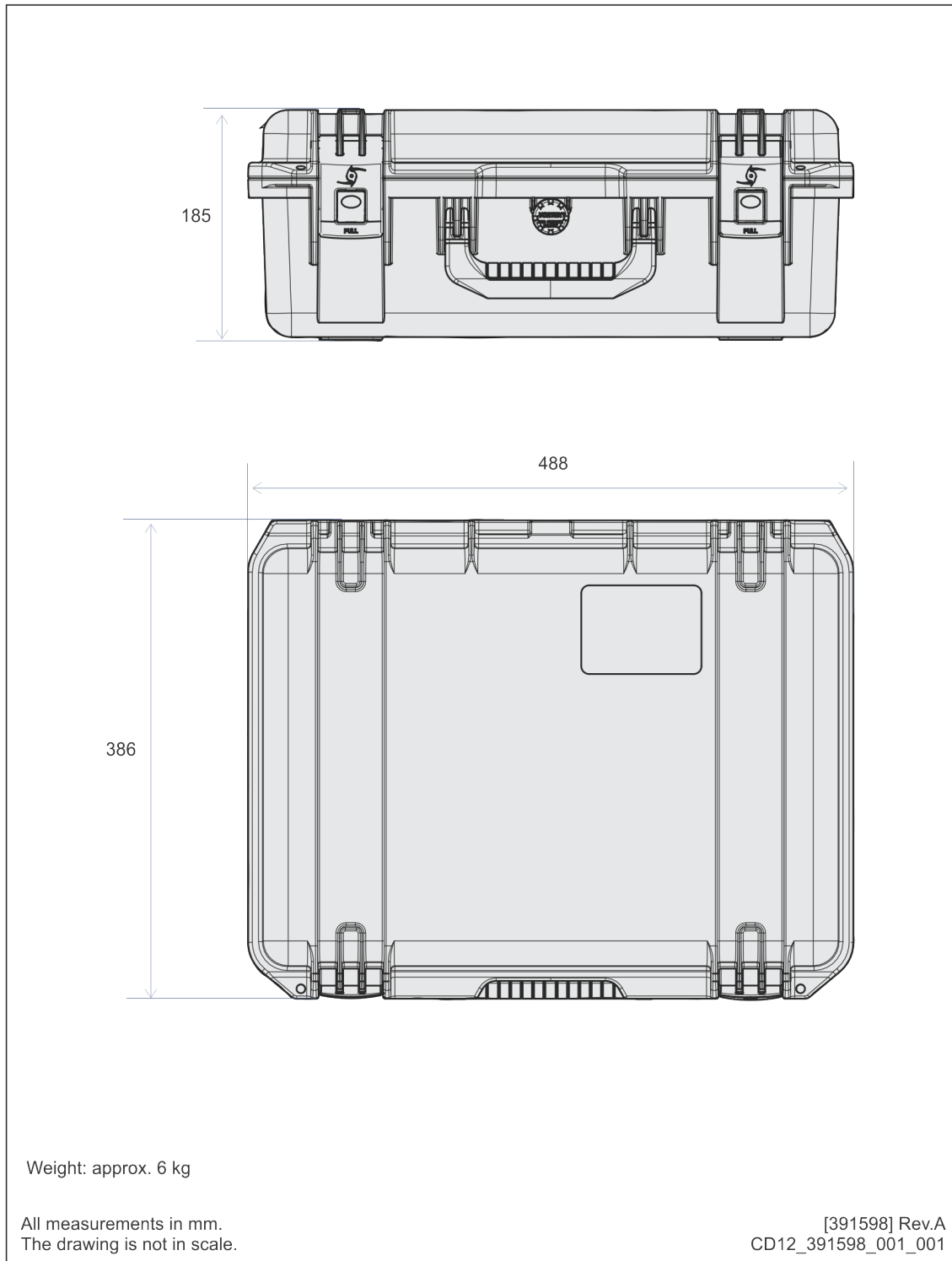

Technical specifications

This chapter provides the technical specifications and requirements related to the Kongsberg ACS500.

Note

In Kongsberg, we are continuously working to improve the quality and performance of our products. Technical specifications may therefore be changed without prior notice.

Topics

- *Acoustic link* on page 122
- *Performance specifications* on page 123
- *Weights and outline dimensions* on page 124
- *Power specifications* on page 125
- *Environmental specifications* on page 126

Acoustic link

This section provides information about the acoustic link for Kongsberg ACS500.

The ACS500 communication system consists of a modem implemented on the Universal Transponder Board (UTB) in both the ACU and the SCU. Each UTB board is directly connected to a transducer in order to send acoustic telegrams in water depths up to 4000 m.

An acoustic telegram is sent from either the ACU computer or the ACU control on the computer onboard the ship/rig.

The signal is received by one of the subsea transducers depending on which SCU the operator has chosen to send the signal to. The telegram is then transferred via a serial line connection to the SCU control module. The SCU control module will perform all the basic control of valve solenoids and read back for sensors. A signal is sent back to the ACU/APC as a confirmation that the operation is completed.

Two basic link principles are available in the UTB modems:

- The optimal and fast Cymbal spread spectrum coherent acoustic link
- The well-known non coherent FSK principle with a number of transmitted CW pulses with a number of different frequencies

FSK coding has been used for the previous generations of ACS systems.

The reason why two different acoustic link principles are available is to be able to use the most optimal solution when needed, according to the present acoustic environment conditions.

The Cymbal Link system will operate with reduced battery consumption at severe signal to noise ratio compared to the FSK system, though the FSK system, with narrow beam pulse detectors is more robust regarding difficult reflection patterns in the acoustic channel.

Specification

Cymbal

- Standard cymbal link configuration
 - Spread spectrum transmission.
Typical speed 150 bits/s
- Cymbal frequency area
 - 25.6 kHz centre frequency \pm 2 kHz

FSK

- Standard FSK telemetry with 7 frequencies
 - 12 bits/s data transmission speed
- FSK frequency area
 - 24.5 kHz to 26.5 kHz
- FSK wake up

- 23.5 kHz to 24.5 kHz

Performance specifications

This section provides the performance specifications for the Kongsberg ACS500.

Acoustic Command Unit

- Degree of protection: IP54

Subsea Control Unit

- Operating depth: 4000 m
- Communication principle: Phase Shift Keying and Frequency Shift Keying
- Operating frequencies Cymbal: 23.6 kHz to 27.6 kHz
- Wake up codes, Cymbal: M53/M54
- Operating frequencies FSK: 25.0 kHz to 26.5 kHz in steps of 250 Hz
- Wake up frequencies, FSK: Channel 76: 24 and 23.5 kHz
- Wake up frequencies, FSK: Channel 86: 24.5 and 23.5 kHz
- Max transmission power: 300 W

Common for transducers

- Operating frequency: 21 kHz to 31 kHz

TDD30V dunking transducer

- Beam width: approximately 30° at –3 dB

TDD303 dunking transducer

- Beam width: approximately 50° at –3 dB

TDD180 dunking transducer

- Beam width: approximately 90° at 3 dB

TDR30V subsea transducer

- Beam width: approximately 30° at –3 dB

TDR40V subsea transducer

- Beam width: approximately 50° at –3 dB

TDR180 subsea transducer

- Beam width: approximately 90° at 3 dB

Weights and outline dimensions

This section provides the technical specifications and requirements related to weight and outline dimensions.

For more detailed information about the dimensions, refer to the chapter *Drawing file* on page 110.

Acoustic Command Unit

- Width: 488 mm
- Height: 185 mm
- Depth: 386 mm
- Weight: Approximately 19.5 kg

Dunking transducers

- Width: 225 mm
- Height: 500 mm
- Depth: 590 mm
- Weight: Approximately 25 kg

TDR30V

- Diameter: 166 mm
- Height: 202 mm
- Weight: 15 kg
- Cable length: 15 m

TDR40V 34S

- Diameter: 142 mm
- Height: 164 mm
- Weight: 15 kg
- Cable length: 15 m

TDR180

- Diameter: 166 mm
- Height: 225 mm
- Weight: 14 kg
- Cable length: 15 m

Junction box

- Width: approximately 210 mm
- Depth: approximately 180 mm
- Height: 112 mm

External quad battery

- Diameter: 304 mm
- Height: 947.5 mm
- Weight: approximately 165 kg

Power specifications

This section provides the technical specifications and requirements related to the power supply.

Acoustic Command Unit

- Input voltage: 100 to 240 VAC (47 to 63 Hz)
- Operating voltage: 10 to 18 VDC
- Number of batteries: 1
- Cells per battery: 7
- Type of cells: Lead/Acid
- Battery output: 14 VDC
- Maximum transmission power: 300 W
- Battery usage: approximately 10 hours continual use

Subsea Control Unit

- Operating voltage: 10 to 18 VDC
- Number of batteries: 1
- Cells per battery: 48
- Type of cells: Lithium
- Battery output: 14 VDC
- Total battery energy content: 128 Ah

External quad battery

- Number of batteries: Maximum 4
- Cells per battery: 48
- Type of cells: Lithium
- Battery output: 14 VDC
- Total battery energy content: Maximum 4 x 128 Ah

Environmental specifications

This section provides the technical specifications and requirements related to the environmental conditions.

Acoustic Command Unit

- Operation temperature: -5 to +55°C
- Storage temperature: -30 to +70°C

Subsea Control Unit

- Operational temperature: -5 to +55°C
- Storage temperature: -30 to +70°C

Operational specification for on deck testing purposes: -20 to +55°C. ACU30 must be in standby/power ON mode before being exposed to temperatures below -5°C.

Lithium batteries safety procedures

This chapter includes safety information for the Kongsberg equipment with lithium battery, and separate Kongsberg lithium batteries. It also includes emergency procedures.

WARNING

This chapter must be read before handling equipment with lithium batteries and separate lithium batteries.

SECTION 1: Identification

Product name

The SCU contains a custom made lithium battery.

- **Product name:** SCU battery
- **Part number:** 319554
- **Manufacturer:** Kongsberg Maritime AS
- **Address:** Strandpromenaden 50, 3190 Horten, Norway
- **Telephone:** +47 33 03 24 07 (24 h)
- **Telefax:** +47 33 04 29 87
- **E-mail address:** km.support.hpr@kongsberg.com
- **Website:** <http://www.km.kongsberg.com>

Note

The battery is provided as a solid and sealed unit. The battery cannot be opened to reveal individual cells.

Hazards identification

The battery is not provided with any hazards identification. It is not classified as dangerous or hazardous with normal use.

The battery should not be opened or burned. The battery contains dangerous ingredients. Exposure to the ingredients contained within the battery cells could be harmful. The battery cells include a barrier preventing exposure to the user and environment. The battery cells are not classified as hazardous according to Regulation (EC) No. 1272/2008.

The chemicals in the battery cells are contained in a sealed enclosure. Risk of exposure occurs only if the cell is mechanically, thermally or electrically abused to the point of compromising the enclosure. If this occurs, exposure to the electrolyte solution contained within can occur by inhalation, ingestion, eye contact and skin contact. The electrolyte solution would be corrosive and can cause irritation and burns.

Other hazards

- **Over charge** - If the cells that form the battery block are overcharged, the results may be a thermal runaway.
- **External fire** - Internal pressure and thermal runaway may be the consequences if the cells inside the battery are exposed to temperatures above 85 °C.
- **Internal short circuit** - Internal short circuit in a cell. Destruction of the separator can cause a short circuit between the anode and cathode. Thermal runaway and fire is possible.
- **Water ingression** - Internal pressure, thermal runaway and chemical reactions may be the consequence.

The transponder has a pressure relief valve at the bottom of the unit. The relief valve prevents overpressure. Noxious gases and ingredients will then leak out of the transponder until the chemical reactions have stopped. Products generated by the chemical reactions during an emergency may however clog this pressure release valve.

SECTION 3: Composition

The battery is a solid, manufactured article.

A transponder lithium battery consists of **Lithium Metal** cells with the formula: **Lithium Thionyl Chloride - Li/SOCl₂**

- **Negative electrode:** Lithium metal (Li)
- **Positive electrode:** Carbon
- **Electrolyte:** Solution of lithium tetrachloroaluminate (LiAlCl₄) in thionyl chloride
- **Product name:** SCU battery/cNODE Maxi battery
- **Part number:** 319554
- **Lithium weight:** 183 g

Battery cell manufacturers/types

A transponder lithium battery consists of cells from one or two of the following manufacturers and types:

- Tadiran TL-2300
- Sonnenschein SL-780
- Saft LS 33600
- Saft LSH 20
- Sonnenschein SL-760

Battery design

A transponder lithium battery consists of several battery cells that are electrical connected, both in serial and parallel.

There are transponder batteries with different number of cells, voltages and capacity.

All transponder batteries include protection against short-circuits (re-settable fuses) and reverse current (diodes).

SECTION 4: First-aid measures

The battery will release toxic fumes if burned or exposed to fire. If subjected to gas from a burning battery, remove the source of contamination or move the victim to fresh air. Seek medical advice.

Inhalation:	The chemicals are lung irritant. Remove from exposure, rest and keep warm.
Skin contact:	The chemicals are skin irritant. Wash off skin thoroughly with water. Remove contaminated clothing and wash it before reuse.
Eye contact:	The chemicals are eye irritant. Irrigate thoroughly with water for at least 15 minutes.
Ingestion:	Exposure to the chemicals may cause tissue damage to throat and gastro/respiratory tract if swallowed. Wash out mouth thoroughly with water and give plenty of water to drink. Seek medical advice.

SECTION 5: Fire-fighting measures

The battery in which the battery pack is used is designed to withstand damage to the internal battery pack. Nonflammable material is used. In case of fire, move the battery from the fire area if you can do it without risk. Extreme mechanical abuse to the battery may result in ruptured seal and exposure.

- 1 If possible, move the battery and/or the SCU away from the fire.
- 2 Cool down the battery with lots of cold water.
 - Immerse the battery and/or the SCU in the sea for minimum 24 hours.
 - If this method is impossible, it can be cooled down with a fire hose.

Cooling down the battery with lots of cold water is the only way to reduce/stop the internal chemical reactions, or to limit the fire/explosions to as few battery cells as possible. The chemical reactions/fire will continue without additional supply of oxygen, so extinguisher like Lith-X will not work properly.

Applying water directly onto a battery may develop hydrogen gas, due to the possible electrolysis if the battery terminals are exposed to water. Mixed with air, this gas is very inflammable/explosive. However, if the water cooling takes place out on deck, or in a storeroom with good ventilation, there will never be enough hydrogen gas to exceed the lower explosive limit of hydrogen in air (about 4%).

WARNING

Remove SCU with lithium battery and separate lithium batteries in case of an external fire if possible.

SECTION 6: Accidental release measures

During normal operation, accidental release measures are not applicable. Extreme mechanical abuse to the battery may result in ruptured seal, and exposure.

As an immediate precautionary measure, isolate spill or leak area for at least 25 metres (75 feet) in all directions. Keep unauthorized personnel away. Stay upwind, and keep out of low areas. Ventilate closed areas before entering. Wear adequate personal protective equipment.

Prevent material from contaminating soil and from entering sewers or waterways. Stop the leak if safe to do so. Contain the spilled liquid with dry sand or earth. Clean up spills immediately.

Absorb spilled material with an inert absorbent (dry sand or earth). Scoop contaminated absorbent into an acceptable waste container. Collect all contaminated absorbent and dispose of according to relevant regulations. Scrub the area with detergent and water; collect all contaminated water for proper disposal.

SECTION 7: Handling and storage

- 1 Do not open, disassemble, crush or burn the battery.
- 2 Do not expose the battery to temperatures outside the range of -30 °C to 70 °C.
- 3 Store in a dry location.

To minimize any adverse affects on the battery performance it is recommended that it is kept at room temperature (25 °C +/- 5 °C). Elevated temperatures can result in shortened life.

For long term storage the transponder should be fully charged and recharged every 6 months. If the transponders are left to deplete completely, it might be impossible to charge them again.

SECTION 8: Exposure controls and personal protection

Airborne exposures to hazardous substances are not expected when the battery is used for its intended purpose. No protection (respirator, skin and/or eye) is then required. If the battery is damaged, and you are exposed to the chemicals inside it, proper personal protection is required.

In the event of fire or physical damage to the battery, follow the mandatory rules for personal protection.

- **Fire/explosion:** Use self contained breathing apparatus.
- **Exposure to noxious gas:** Chemical resistant gloves and safety glasses.

SECTION 9: Physical and chemical properties

The battery is solid with a firm and hard appearance. No chemicals are exposed during normal use and transportation.

The battery pack is provided as a solid and sealed unit. The battery pack can not be opened to reveal the individual cells.

For additional information about the cells inside the sealed battery pack, see the safety data sheet provided by the cell manufacturer.

SECTION 10: Stability and reactivity

The battery is stable. No specific handling requirements apply.

Avoid exposing the battery to fire or temperatures above 80 °C. Do not disassemble, crush, short or install the battery with incorrect polarity. Avoid mechanical or electrical abuse. Do not immerse in seawater or other high conductivity liquids.

The battery will release toxic fumes if burned or exposed to fire. Breaching of the individual cell enclosure may lead to generation of hazardous fumes which again may include extremely hazardous HF (hydrofluoric acid).

SECTION 11: Toxicological information

Acute oral, dermal and inhalation toxicity data are not available for this battery.

Risk of irritation occurs only if the battery is abused to the point of breaking the container and opening it to reveal the individual cells. If this occurs, irritation to the skin, eyes and respiratory tract may occur.

SECTION 12: Ecological information

The battery is not biodegradable.

Provided that the battery pack is disposed of according to local regulations and/or law, it will not have any environmental impact.

SECTION 13: Disposal considerations

Dispose of in accordance with local, state and federal laws and regulations for batteries.

A lithium thionyl chloride battery does not contain any heavy metals, and is therefore not regarded as special waste (contains only biodegradable parts).

A used lithium battery often contains a significant amount of residual energy. It is the danger of explosion that presents a problem when disposing a battery. Used batteries must therefore be handled with the same care as new ones.

Note

For safe disposal, contact the nearest local company that has been approved to collect and dispose of lithium batteries.

SECTION 14: Transport information

All SCU's with a lithium battery and separate lithium batteries must be shipped in accordance with the prevailing national regulations.

Transport identification codes:

Aircraft:	IATA DGR
Sea Transport:	IMDG Code
Railway:	RID
Road transport:	ADR

Original shipping boxes must be used for all transport.

Only new separate lithium batteries can be transported by air.

Air transport of all SCU's with new lithium battery and new separate lithium batteries by air is only permitted onboard cargo aircraft. The goods must be clearly labelled:
CARGO AIRCRAFT ONLY

Note _____

During transport the lithium battery must always be disconnected from the electronics.

SECTION 15: Regulatory information

Not applicable.

SECTION 16: Other information

The battery cell manufacturers' safety data sheets are available on the following internet addresses:

Saft: www.saftbatteries.com

Tadiran / Sonnenschein: www.tadiranbatteries.de

Appendix A

Type approval certificate



This is to certify:

That the BOP control system

with type designation(s)

Acoustic BOP Control System ACS500

Issued to

**Kongsberg Maritime AS - Subsea Division
HORTEN, Norway**

is found to comply with

DNV GL offshore standards

Application :

See next page.

Location classes:

Temperature	A
Humidity	B
Vibration	A
EMC	B
Enclosure	A

This Certificate is valid until **2021-10-09**.

Issued at **Høvik** on **2016-11-01**

DNV GL local station: **Oslo Drilling Systems**

Approval Engineer: **Jan Olav Moen**



for **DNV GL**

Digitally Signed By: Moen, Jan Olav

Location: DNV GL Høvik, Norway

Signing Date: 2016-11-01, on behalf of

Per Esvall

Head of Section

This Certificate is subject to terms and conditions overleaf. Any significant change in design or construction may render this Certificate invalid. The validity date relates to the Type Approval Certificate and not to the approval of equipment/systems installed.



Job Id: **262.1-019479-2**
 Certificate No: **TAA00000TS**

Product description

The Type Approval is valid with the following Operational Modes and System Functions:

Item:	Description	Part number
ACU30	Acoustic Command Unit	320101
SCU 35-24V 37P TC WA	Subsea Control Unit 5000m 24V with Gisma 37 pin test port connector wiring A	413507
SCU 35-48V 37P TC WA	Subsea Control Unit 5000m 48V with Gisma 37 pin test port connector wiring A	413517
SCU 34-24V 37P WA	Subsea Control Unit 24V with Gisma 37 pin connector wiring A	417592
SCU 34-24V 37P WB	Subsea Control Unit 24V with Gisma 37 pin connector wiring B	417593
SCU 34-24V 37P WC	Subsea Control Unit 24V with Gisma 37 pin connector wiring C	417595
SCU 34-24V 37P WD	Subsea Control Unit 24V with Gisma 37 pin connector wiring D	417597
SCU 34-24V 37P WE	Subsea Control Unit 24V with Gisma 37 pin connector wiring E	417599
SCU 34-24V 37P WF	Subsea Control Unit 24V with Gisma 37 pin connector wiring F	417600
SCU 34-48V 37P WA	Subsea Control Unit 48V with Gisma 37 pin connector wiring A	417603
SCU 34-48V 37P WB	Subsea Control Unit 48V with Gisma 37 pin connector wiring B	417604
SCU 34-48V 37P WC	Subsea Control Unit 48V with Gisma 37 pin connector wiring C	417605
SCU 34-24V 24P TC WA	Subsea Control Unit 24V with MacArtney 24 pin test port connector wiring A	417606
SCU 34-24V 24P TC WB	Subsea Control Unit 24V with MacArtney 24 pin test port connector wiring B	417610
SCU 34-24V 24P TC WC	Subsea Control Unit 24V with MacArtney 24 pin test port connector wiring C	417611
SCU 34-24V-37p 10Ch-X	Subsea Control Unit 24V with Gisma 37 pin 10Ch-X	415881
SCU 34-48V 24P TC WA	Subsea Control Unit 48V with MacArtney 24 pin test port connector wiring A	369340
SCU 34-24V 37P TC WA	Subsea Control Unit 24V with Gisma 37 pin test port connector wiring A	336600
SCU 34-48V 37P TC WA	Subsea Control Unit 48V with Gisma 37 pin test port connector wiring A	336633
SCU 34-24V 55P TC WA	Subsea Control Unit 24V with Gisma 55 pin test port connector wiring A	336644
SCU 34-48V 55P TC WA	Subsea Control Unit 48V with Gisma 55 pin test port connector wiring A	336648
SCU 34 - 24V 24P TC	Subsea Control Unit 24V with MacArtney 24 pin test port connector	332255
SCU 34 24V-37p	Subsea Control Unit 24V with Gisma 37 pin connector	317950
SCU 34 - 48V 37p	Subsea Control Unit 48V with Gisma 37 pin connector	363668
TDD30V	Dunking Transducer Unit TDD30V	320680
TDD301 MF	Dunking Transducer TDD301 MF	129-220871
TDD303 MF	Dunking Transducer TDD303 MF	301518
TDD180	Dunking Transducer TDD180	320822
TDD50V 30L	Dunking Transducer TDD50V with 30m transducer cable and backpack	369519
TDR30V SCU St	Transducer Remote TDR30V SCU St	320098
TDR40V 34S	Transducer Remote TDR40V 34S	364096
TDR180 SCU St	Transducer Remote TDR180 SCU St	320890
TDR30V 34T	Transducer Remote TDR30V 34T	368967
TDR180 34T	Transducer Remote TDR180 34T	370168
TDR30V 34GT	Transducer Remote TDR30V 34GT	336611
TDR90V 34GT	Transducer Remote TDR90V 34GT	336615
TDR180V 34GT	Transducer Remote TDR180V 34GT	336616



Job Id: **262.1-019479-2**
 Certificate No: **TAA00000TS**

TDR30V 35GT	Transducer Remote TDR30V 35GT	413587
External Quad Battery Unit SCU	External Quad Battery Unit SCU	347007

Software Version
 ACU30:

Unit	Description
Panel PC	Microsoft Windows: XP
Panel PC	PC R12ID3S-MRM-2 Microsoft XP and Microsoft windows 7
UTB circuit board	DSP software: ACS Release: v_5_06
UTB circuit board	FPGA firmware: UTBFPGA_v_2_11
SIO circuit board	Microcontroller software: EME software v_1.6

SCU 34:

Unit	Description
UTB circuit board	DSP software: ACS Release: v_5_07
UTB circuit board	FPGA firmware: UTBFPGA_v_2_11
SIO circuit board	Microcontroller software: scu_flash_v_1_18
SIB circuit board	FPGA firmware: v_1_13

Application/Limitation

The system is found to comply according to DNV GL’s current understanding of interpretation and implementation of:

- DNV GL Statutory Interpretations DNVGL-SI-0166 Ch.2 Sec.7 DRILL(N), July 2015.
- DNV GL Offshore standard DNVGL-OS-E101 “Drilling plant”, July 2015
- Specification for Control Systems for Well Control Equipment and Control Systems for Diverter Equipment. API specification 16D, Second Edition, July 2004.
- Blowout Prevention Equipment System for Drilling Operations. API Standard 53, November 2012

The Type Approval covers the type-tested hardware as listed under Product description.

Product certificate

Each delivery of the application system is to be certified according to DNVGL-OS-D202 Ch.3 Sec.1 [3] / DNVGL-OS-E101 Ch.3 Sec.3. The certification test is to be performed at the manufacturer of the application system according to an approved test program before the system is shipped to the yard. After the certification the clause for application software control will be put into force.

Clause for application software control

All changes in software are to be recorded as long as the system is in use on board. The records of all changes are to be forwarded to DNV GL for evaluation and approval. Major changes in the software are to be approved before being installed in the computer.

Job Id: **262.1-019479-2**
Certificate No: **TAA00000TS**

Type Approval documentation

322135A Instruction Manual, ACS500 Emergency Acoustic BOP Control System
331046aa Report, ACS500 FMECA Workshop 9 – 11 February 2009
804047A Report, Transponder Analysis on the effect of external pressure
804827B Report, Transponder Analysis on the effect of external pressure
331172A Factory Acceptance Test, Emergency Acoustic BOP Control System
2009-3103 EMC and environmental testing of emergency acoustic BOP control system ACS500
2012-3354 EMC Test of ACS500 Emergency BOP control system
20355 Application report: Testing of Subsea Control Unit SCU and Subsea Transducer Unit with new connectors GISMA series 16.

Tests carried out

Applicable tests according to class guideline DNVGL-CG-0339, November 2015.

Type Test of Software was carried out. The test was according to an approved test program. After the Type Test of Software the software version nos. were registered.

Periodical assessment

The scope of the periodical assessment is to verify that the conditions stipulated for the type are complied with, and that no alterations are made to the product design or choice of systems, software versions, components and/or materials.

The main elements of the assessment are:

- Ensure that type approved documentation is available
- Inspection of factory samples, selected at random from the production line (where practicable)
- Review of production and inspection routines, including test records from product sample tests and control routines
- Ensuring that systems, software versions, components and/or materials used comply with type approved documents and/or referenced system, software, component and material specifications
- Review of possible changes in design of systems, software versions, components, materials and/or performance, and make sure that such changes do not affect the type approval given
- Ensuring traceability between manufacturer's product type marking and the type approval certificate

Periodical assessment is to be performed at least every second year and at renewal of this certificate.

This type approval certificate replaces type approval certificate A-14252.

END OF CERTIFICATE

Appendix B Information from the connector producer

3 HANDLING INSTRUCTIONS FOR THE GISMA CONNECTORS

Download the latest information from [GISMA](#).

Index

A

- Acoustic Command Unit
 - change battery, 75
 - charge, 74
 - clean, 74
 - Line replaceable units, 92–93
 - Power level, 44
- Acoustic mode
 - Change, 45
- ACS500
 - cable layout, 22
 - familiarization, 10
 - introduction, 10
 - main units, 13
 - System description, 11
- ACU
 - Battery level, 43
 - charge, 74
 - clean, 74
 - description, 13
 - Fault finding, 53
 - Line replaceable units, 92–93
 - outline dimensions, 112
 - Power level, 44
 - System status, 46
- ACU battery, 74–75
- ACU battery level, 43
- ACU maintenance, 74–75
- Approval
 - installation drawings, 18
- Audience
 - this manual, 9
- Auto Shut Down, 49

B

- Basic description
 - ACU, 13
- Battery
 - Battery level, 43
- Battery level, 43
 - ACU, 43
 - external batteries, 44
 - SCU, 43
- Battery status, 38
- Brightness
 - Changing the brightness, 35

C

- Cable drum
 - close, 29
 - open, 28
- cable layout, 22
- cable list, 24

- cable procedures, 25
- cables, 22
- cabling
 - cable list, 24
 - procedures, 25
- Change acoustic mode, 45
- Change time, 39
- Changing the brightness, 35
- Classification society
 - approval, 18
- Closing the cable drum, 29
- Communication, 46
- Connecting simulator, 69
- Cymbal
 - Change to, 45

D

- Description
 - ACU, 13
- Diagram
 - system, 12
- Digital pressure indicator
 - change battery, 89
- Disposal
 - equipment, 103
- DNV certificate, 135
- Drawing
 - ACU outline
 - dimensions, 112
 - dunking transducer
 - outline dimensions, 111
 - quad battery unit outline
 - dimensions, 119
 - SCU outline dimensions, 113
 - Subsea transducer
 - TDR180 outline
 - dimensions, 118
 - Subsea transducer
 - TDR30V outline
 - dimensions, 116
 - Subsea transducer
 - TDR40V 34S outline
 - dimensions, 117
 - system, 12
 - Drawings, 110
 - Dunking transducer
 - check, 76
 - clean, 76
 - Line replaceable units,
 - 92, 94
 - outline dimensions, 111
 - Dunking transducer
 - maintenance, 76

E

- EME
 - Emergency sequence, 48
- Emergency sequence, 48
- environmental
 - specifications, 126
- equipment
 - receipt, 15
 - responsibility, 15
 - storage, 15
 - unpacking, 15
- Equipment
 - disposal, 103
 - handling, 102
 - inspection, 103
 - lifting, 103
 - re-packaging, 104
 - storage after unpacking, 104
 - storage after use, 105
 - storage before use, 106
 - transportation, 109
 - unpacking, 107
- Execute, 40
- Exit, 40
- External battery level, 44
- External quad battery
 - change battery, 84
 - outline dimensions, 119
- External quad battery unit
 - open, 83

F

- familiarization
 - ACS500, 10
- Fault finding
 - ACU, 53
- FSK
 - Change to, 45

G

- general supply conditions, 15
- Getting started, 28

H

- Help, 40
- How to
 - assemble the interseal
 - test kit, 87
 - change the ACU battery, 75
 - change the battery on
 - the pressure indicator, 89
 - change the external quad
 - battery, 84

- change the SCU battery, 79
 - change the subsea transducer, 85
 - charge the ACU, 74
 - check the dunking transducer, 76
 - clean the ACU, 74
 - clean the dunking transducer, 76
 - clean the Subsea Control Unit, 77, 83
 - clean the subsea transducer, 85
 - duplicate SCU configuration, 81
 - install the SCU, 19
 - install transducer, 20
 - open the quad battery, 83
 - open the SCU, 78
 - Start normal operation, 30–31, 41
 - test the SCU, 80
 - use the interseal test kit, 88
 - humidity specifications, 126
- I**
- Inspection equipment, 103
 - Installation drawings, 110
 - planning, 17
 - SCU, 19
 - Subsea Control Unit, 19
 - subsea transducer, 20
 - transducer, 20
 - Installation drawings approval, 18
 - interconnection cables, 22
 - Interseal test SCU, 80
 - Interseal test kit assemble, 87
 - test, 88
 - Interseal test maintenance, 89
 - introduction ACS500, 10
- K**
- Kongsberg ACS500 familiarization, 10
 - introduction, 10
- L**
- Lifting equipment, 103
 - Line replaceable units, 91
 - Acoustic Command Unit, 92–93
 - dunking transducers, 92, 94
 - Subsea Control Unit, 92, 95
 - subsea transducers, 92, 98
 - Test equipment, 92, 100
 - list cables, 24
 - List spare parts, 91
 - LRUs Acoustic Command Unit, 92–93
 - dunking transducers, 92, 94
 - SCU, 92, 95
 - subsea transducers, 92, 98
 - Test equipment, 92, 100
- M**
- main units, 13
 - Maintenance, 73
 - procedures, 73
 - Maritime authority approval, 18
 - Mechanical drawings, 110
 - Menu bar, 37
 - More status, 39
- N**
- Normal operation, 31, 41
 - Valves, 31, 41
- O**
- Online help, 40
 - Open quad battery, 83
 - Open SCU, 78
 - Opening the cable drum, 28
 - Operating system ACU, 13
 - Operation log, 37
 - Outline dimensions Acoustic Command Unit, 112
 - drawings, 110
 - dunking transducer, 111
 - Quad battery unit, 119
 - Subsea Control Unit, 113
 - Subsea transducer TDR180, 118
 - Subsea transducer TDR30V, 116
 - Subsea transducer TDR40V 34S, 117
- P**
- Planning installation, 17
 - Power level ACU, 44
 - SCU, 45
 - procedure cabling, 25
 - Procedure assemble the interseal test kit, 87
 - change subsea transducer, 85
 - change the ACU battery, 75
 - change the battery on the pressure indicator, 89
 - change the external quad battery, 84
 - change the SCU battery, 79
 - charge ACU, 74
 - check the dunking transducer, 76
 - clean ACU, 74
 - clean dunking transducer, 76
 - clean SCU, 77, 83
 - clean subsea transducer, 85
 - duplicate SCU configuration, 81
 - install the SCU, 19
 - install transducer, 20
 - open the external quad battery unit, 83
 - open the SCU, 78
 - Starting normal operation, 30–31, 41
 - testing the SCU, 80
 - using the interseal test kit, 88
 - Procedures maintenance, 73
 - user settings, 44
 - Product recycling, 103
 - Purpose SCU, 14
 - Simulator, 14
 - this manual, 9
 - Transducer, 13–14
- Q**
- Quad battery maintenance, 84
- R**
- Re-packaging equipment, 104
 - Read sensor input, 47

Read software version, 47
Reader
 this manual, 9
receipt
 equipment, 15
Recycling, 103
registered trademarks, 9
Replaceable units
 catalogue, 91
responsibility
 equipment, 15

S

SCU
 Battery level, 43
 clean, 77, 83
 duplication, 81
 installation, 19
 Line replaceable units,
 92, 95
 outline dimensions, 113
 Power level, 45
 purpose, 14
 Solenoid Information, 40
SCU battery, 79
SCU battery level, 43
SCU maintenance, 77–79,
 81, 83
Sensor alarm, 39
Sensor input, 39
 Read, 47
Setting up a spare SCU, 81
Simulation, 67
Simulator, 69, 71
 Connecting, 69
 Connecting with HiPAP, 71
 purpose, 14
Simulator with HiPAP, 71
Software version
 Read, 47
Solenoid information, 40
Spare parts
 catalogue, 91
specifications
 environmental, 126
 humidity, 126
 temperatures, 126
Starting normal operation,
 30–31, 41
storage, 15
Storage
 equipment (after
 unpacking), 104
 equipment (after use), 105
 equipment (before use), 106
Subsea Command Unit
 cloning, 81

 duplication, 81
Subsea Control Unit
 change battery, 79
 installation, 19
 Line replaceable units,
 92, 95
 open, 78
 Power level, 45
Subsea telemetry power, 40
Subsea transducer
 change, 85
 clean, 85
 Line replaceable units,
 92, 98
 outline dimensions, 116–118
Subsea transducer
 maintenance, 85
supply conditions, 15
System
 diagram, 12
System Configuration, 37
System description
 ACS500, 11
System status, 38
 ACU, 46
System Status, 46
 Communication, 46
System status
 communication, 46
System status information, 46
system units, 13

T

Target audience
 this manual, 9
TDR180
 outline dimensions, 118
TDR30V
 outline dimensions, 116
TDR40V 34S
 outline dimensions, 117
Telemetry power, 40
temperature
 specifications, 126
Test, 67
Test equipment
 Line replaceable units,
 92, 100
This manual
 purpose, 9
 target audience, 9
trademarks, 9
Transducer
 installation, 20
 purpose, 13–14
Transducers

 Line replaceable units,
 92, 94, 98
Transportation
 equipment, 109
Type approval certificate, 135

U

units
 main, 13
unpacking, 15
Unpacking
 equipment, 107
User settings
 procedures, 44
Utilities, 37

V

Valve operation, 31, 41

W

Waste Electrical and
 Electronic Equipment, 103
WEEE, 103

©2018 Kongsberg Maritime